



Integra™ Ruggles™-Redmond™
Neuro/Spine Surgical Instruments

General Information

Ordering & Warranty	ii
Trademarks	iii
Scales	iv-v
Instrument Measuring Guidelines	vi-viii

Access Instrumentation..... I

Cranial Burrs & Drills.....	2
Saws	5
Knives/Retinaculotome.....	7
Dura Hooks	8
Nerve Hooks.....	10
Separators	11
Dissectors and Elevators.....	13
Osteotomes.....	23
Gouges	25
Impactors.....	26

Retractors..... 27

Anterior Cervical Fusion Distraction System.....	28
ACF System.....	28
MLD System.....	33
UMLD System	34
Flexi-Spine™ Retraction System	36
RUGGLES™ Spinal Retraction System.....	38
LumbarTrak Retractor System.....	40
Spetzler Sonntag Trans-Oral Retractor System	44
McCulloch Retractor System.....	49
Spatulas.....	51
Nerve Root.....	55
Hand-Held.....	58
Spreaders.....	62
Scalp.....	64
Self-Retaining.....	65
Traction Tongs	76

Rongeurs..... 77

Bone Rongeurs.....	78
Wire Cutters.....	86
Intervertebral Disc Rongeurs	87
Micro Kerrison Rongeurs	99
Bayonet Kerrison Rongeurs.....	103
Medium Kerrison Rongeurs	104
Spurling Kerrison Rongeurs.....	107
Ferris-Smith Kerrisons Rongeurs.....	112
Ejector Kerrisons	113
Curved Kerrison.....	115

Curettes 119

Ultra-Coat Curettes.....	120
Spinal Fusion Curettes.....	122
Thoraco-Lumbar Curettes	128
Extended Reach Curettes	128
Bone Cutters.....	129
Cobb Style Curettes.....	129
Microsurgical Curettes	130
Ring Curettes	132
Bayonet Curettes	133
Cervical Axial Curettes.....	134
Lumbar Axial Curettes	136
Lumbar Bayonet Curettes.....	136

Suction Tubes..... 137

Frazier Suction Tubes.....	136
Poppen Suction Tubes.....	141
Multi-Hole Suction Tubes	142
Endonasal Suction Tubes	144
Bayonet Suction Tubes.....	145
Tapered Teardrop Suction Tubes.....	146

Microsurgical Instrumentation..... 149

Micro Dissection	150
Micro Titanium.....	169
Micro Hooks.....	172
Micro Forceps	176
Bipolar Forceps.....	180
Micro Scissors	193
Micro Needle Holders	200
Ring Handled Forceps and Scissors	204
Speculums.....	208
Transphenoidal.....	209
Endonasal.....	213

Indexes 215

Alphabetical Index.....	216
Numerical Index.....	220

Pricing:

Prices stated in specific written quotations are firm for thirty days from the date given, and are otherwise subject to change without prior notice. Pricing terms stated on written agreements are governed by such agreements.

Shipments:

F.O.B. Integra LifeSciences point of shipment within the continental United States. Shipping costs (including freight and insurance), shall be prepaid by Integra LifeSciences and invoiced to customers.

Ordering Procedure:

A written purchase order on customer's form may be requested for purchases of Integra LifeSciences products.

Acceptance of Orders:

Orders are accepted upon approval by Integra LifeSciences.

Return Policy:

- Authorization, from customer service, must be obtained prior to returning product within 90 days of receipt of product.
- Sterile product must be returned in unopened, undamaged cartons, packed to prevent damage.
- Non-sterile product must be returned in unused saleable condition in original package.
- Credit will be issued for goods returned prior to ninety days from ship date with a 20% restocking charge. This assumes that the product returned is not damaged and can be verified to have not been used or opened.

For Product Instructions for Use, please visit www.integralife.com/jarit

Integra Standard Warranty

INTEGRA LIFESCIENCES CORPORATION ("INTEGRA") warrants to the original purchaser only that each new INTEGRA product is free from manufacturing defects in material and workmanship under normal use and service for a period of two (2) years (except as otherwise expressly provided as to accessory items) from the date of delivery by INTEGRA to the first purchaser, but in no event beyond the expiration date stated on any product labeling.

Surgical instruments are guaranteed to be free from defects in material and workmanship when maintained and cleaned properly and used normally for their intended purpose.

Any covered product that is placed by INTEGRA under a lease, rental or installment purchase agreement and that requires repair service during the term of such placement agreement shall be repaired in accordance with the terms of such agreement.

If any covered defect occurs during the warranty period or term of such placement agreement, the purchaser should communicate directly with INTEGRA's home office. If purchaser seeks to invoke the terms of this warranty, the product must be returned to INTEGRA at its home office. The defective product should be returned promptly, properly packaged and postage prepaid. Loss or damage in return shipment to INTEGRA shall be at CUSTOMER's risk. INTEGRA's sole responsibility under this warranty shall be repair or replacement, at INTEGRA's sole discretion at INTEGRA's expense, subject to the terms of this warranty and applicable agreements. **IN NO EVENT SHALL INTEGRA BE LIABLE FOR ANY INCIDENTAL, INDIRECT, CONSEQUENTIAL OR PUNITIVE DAMAGES IN CONNECTION WITH THE ACQUISITION OR USE OF ANY INTEGRA PRODUCT.** Further, this warranty shall not apply to, and INTEGRA shall not be responsible for, any loss arising in connection with the purchase or use of any INTEGRA product that has been repaired by anyone other than an authorized INTEGRA service representative or altered in any way so as, in INTEGRA's judgment, to affect its stability or reliability, or which has been subject to misuse, negligence or accident, or which has been used otherwise than in accordance with the instructions furnished by INTEGRA. **THIS LIMITED WARRANTY IS EXCLUSIVE AND IN LIEU OF ALL OTHER WARRANTIES, EXPRESS OR IMPLIED, AND OF ALL OTHER OBLIGATIONS OR LIABILITIES ON INTEGRA'S PART, AND INTEGRA NEITHER ASSUMES NOR AUTHORIZES ANY REPRESENTATIVE OR OTHER PERSON TO ASSUME FOR IT ANY OTHER LIABILITY IN CONNECTION WITH INTEGRA'S PRODUCTS.**

INTEGRA DISCLAIMS ALL OTHER WARRANTIES, EXPRESS OR IMPLIED INCLUDING ANY IMPLIED WARRANTY OF MERCHANTABILITY OR OF FITNESS FOR A PARTICULAR PURPOSE OR APPLICATION OR WARRANTY OF QUALITY AS WELL AS ANY EXPRESS OR IMPLIED WARRANTY TO PATIENTS. No warranty or guarantee may be created by any act or statement nor may this Standard Warranty be modified in any way, except as a result of a writing signed by an officer of INTEGRA. These limitations on the creation or modification of this warranty may not be waived or modified orally or by any conduct.

Trademarks

The following are trademarks of Integra LifeSciences Corporation or its subsidiaries:







RUGGLES™
Flexi-Spine™
Stealth™
Diamond™
Redmond™
LumbarTrak™
Ultra-Coat™
BUZZ™
BUZZ Lite™

















Miltex GmbH
Muehlstrasse 6
78604 Rietheim-Weilheim, Germany





French Catheter Scale

(measured by outside diameter)

3Fr	4Fr	5Fr	6Fr	7Fr	8Fr	9Fr
						
1mm	1.39mm	1.67mm	2mm	2.3mm	2.7mm	3mm
.039"	.053"	.066"	.079"	.092"	.105"	.118"

10Fr	11Fr	12Fr	13Fr	14Fr	15Fr	16Fr
						
3.3mm	3.7mm	4mm	4.3mm	4.7mm	5mm	5.3mm
.131"	.144"	.158"	.170"	.184"	.197"	.210"

17Fr	18Fr	19Fr	20Fr	22Fr	24Fr	26Fr
						
5.7mm	6mm	6.3mm	6.7mm	7.3mm	8mm	8.7mm
.223"	.236"	.249"	.263"	.288"	.315"	.341"

28Fr	30Fr	32Fr	34Fr
			
9.3mm	10mm	10.7mm	11.3mm
.367"	.393"	.419"	.445"

IVD Rongeurs · Cup Size

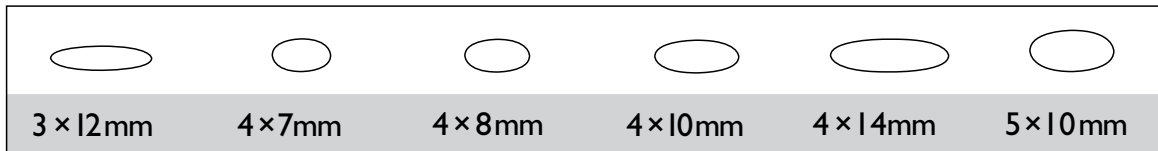
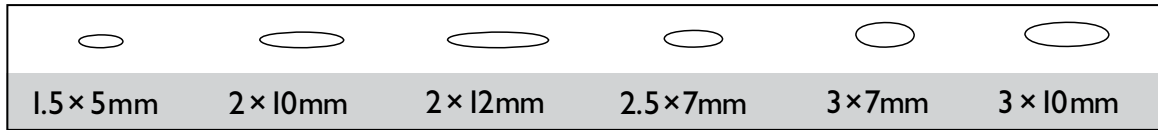

Kerrison Rongeurs · Bite Size

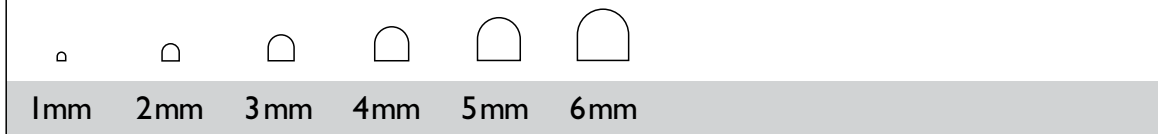

Kerrison Rongeur Cutting Angles

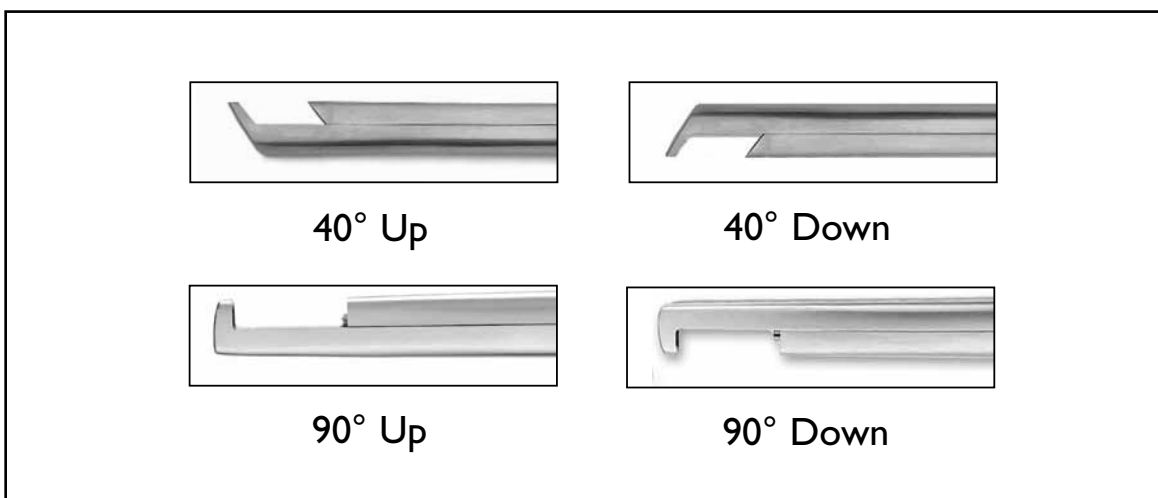

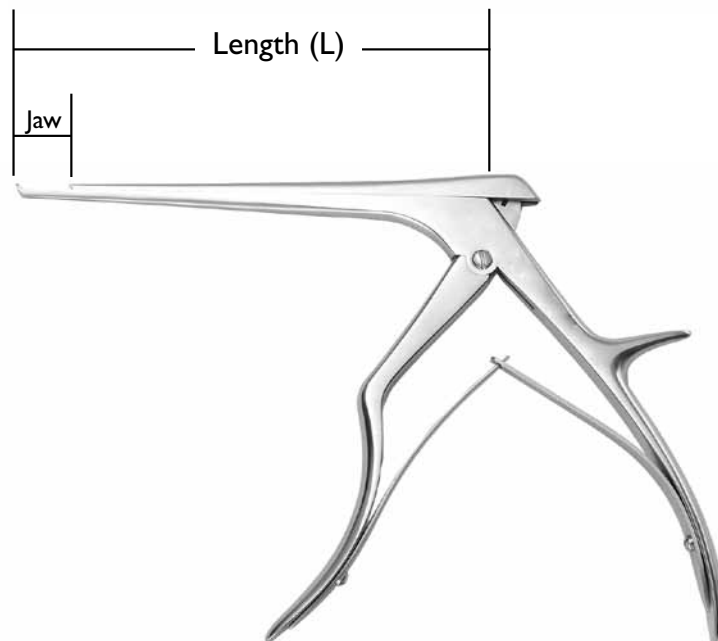
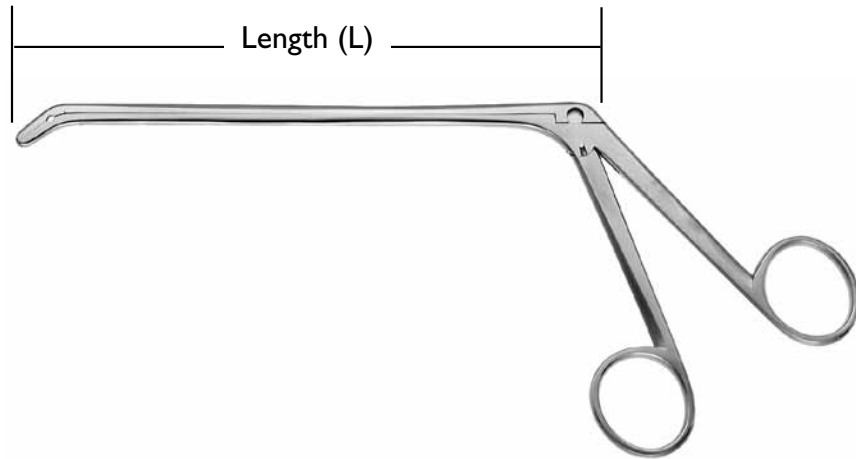
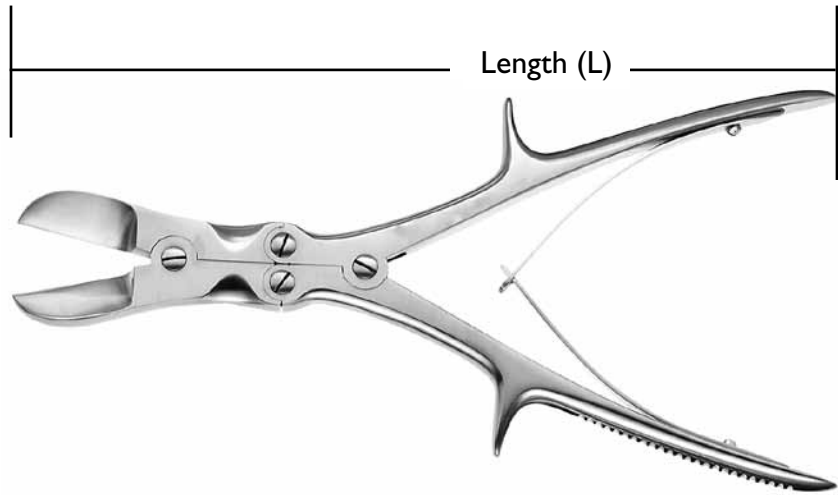

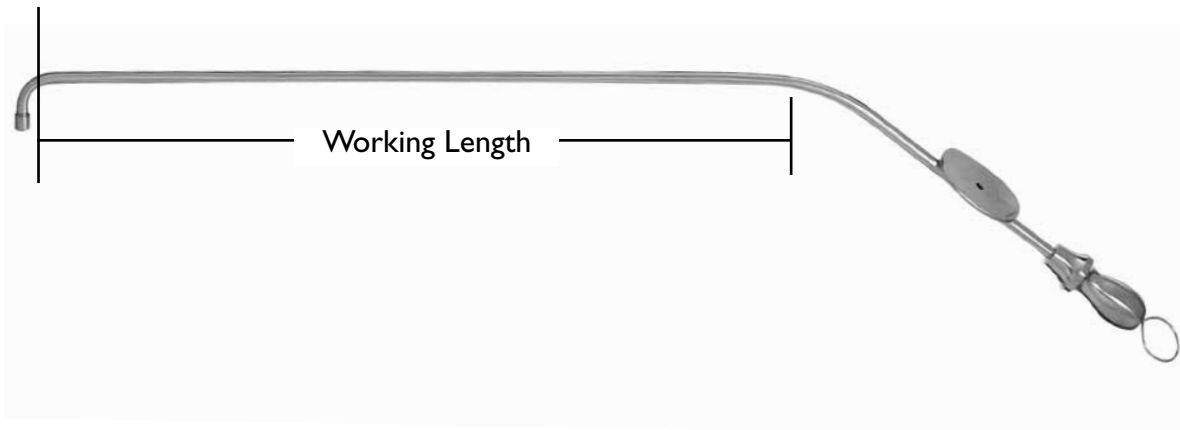
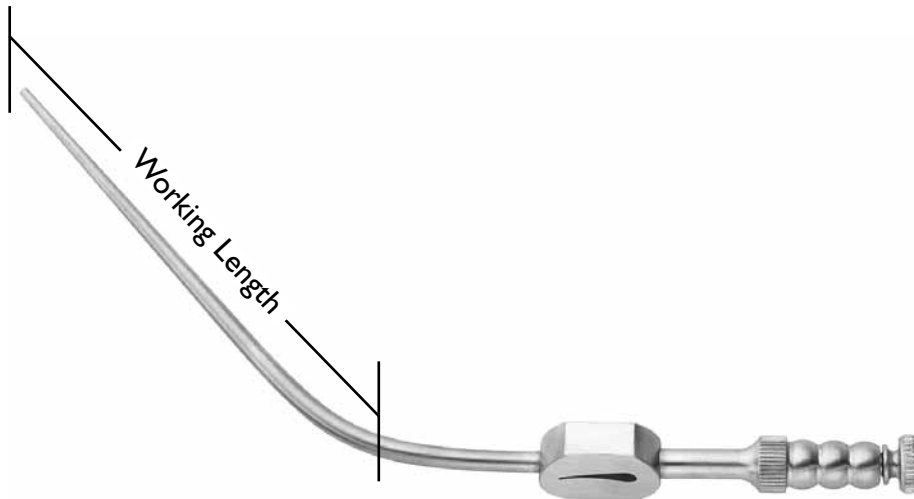
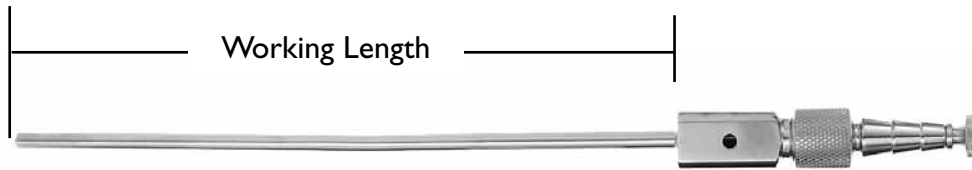





ACCESS INSTRUMENTATION



Cushing Perforating Drill

Catalog#	Length	Width
R0010	3 1/2" (89mm)	3/8" (10mm)
R0015	3 1/2" (89mm)	1/2" (13mm)
R0020	3 1/2" (89mm)	5/8" (16mm)



R0015

Cushing Burr

Catalog#	Length	Width
R0025	3 1/2" (89mm)	3/8" (10mm)
R0030	3 1/2" (89mm)	1/2" (14mm)
R0035	3 1/2" (89mm)	7/8" (21mm)



R0035

Hudson Burr

Catalog#	Length	Width
R0040	3 7/8" (98mm)	3/8" (10mm)
R0041	3 3/4" (95mm)	1/2" (13mm)
R0042	3 3/4" (95mm)	5/8" (16mm)
R0043	4" (102mm)	7/8" (21mm)



R0040



R0041



R0042



R0043

McKenzie Perforating Drill

Catalog#	Length	Width
R0060	3 ⁷ / ₈ " (98mm)	1/2" (13mm)



R0060

McKenzie Enlarging Burr

Catalog#	Length	Width
R0065	3 ³ / ₄ " (95mm)	1 ¹ / ₁₆ " (17mm)



R0065

D'Errico Perforating Drill

Catalog#	Length	Width
R0070	3 ³ / ₄ " (95mm)	5/8" (16mm)



R0070

Hudson Extension

Catalog#	Length
R0080	3 ⁷ / ₈ " (98mm)



R0080

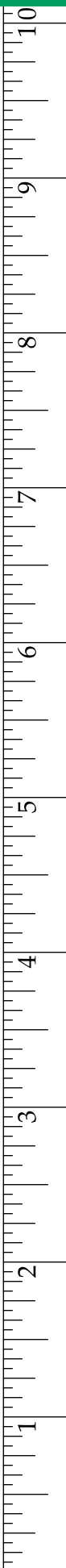



Hudson Brace

Catalog#	Description	Length
R0075	Thumb Screw Lock	9¼" (235mm)
R0076	Snap Lock	9¾" (248mm)



R0075

Hudson Cranial Drill Set

Catalog#	Description
R0085	Complete Set Includes: one (1) Hudson Brace one (1) Hudson Extension four (4) Hudson Burrs R0040, R0041, R0042, R0043

Bunnell Hand Drill, with Jacobs Chuck

Takes standard twist drills

Catalog#	Diameter
R0088	3/8" (10mm)



R0088

Gigli Saw Handle

One Pair

Catalog#	Description
RN0074	Loop Handle
RN0075	Solid "T" Handle

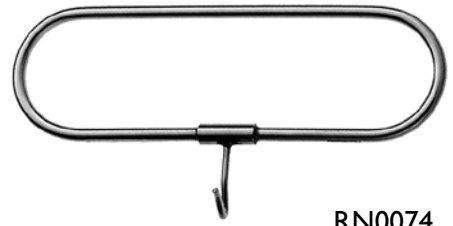

RN0074

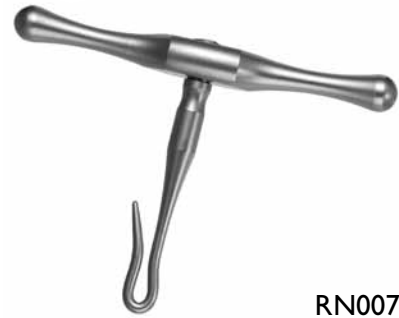

RN0075

Strully-Gigli Handle

One Pair

Blade Lock, One Pair

The Strully-Gigli saw handles have a quick and easy locking device which prevents disengagement of the saw blade from the handle.

Catalog#	Description
RN0076	Loop Handle
RN0077	Solid "T" Handle



RN0076



RN0077





Gigli Saw Blades

Catalog#	Length
RN0070	9" (229mm)
RN0071	12" (305mm)
RN0072	20" (508mm)
RN0073	30" (762mm)

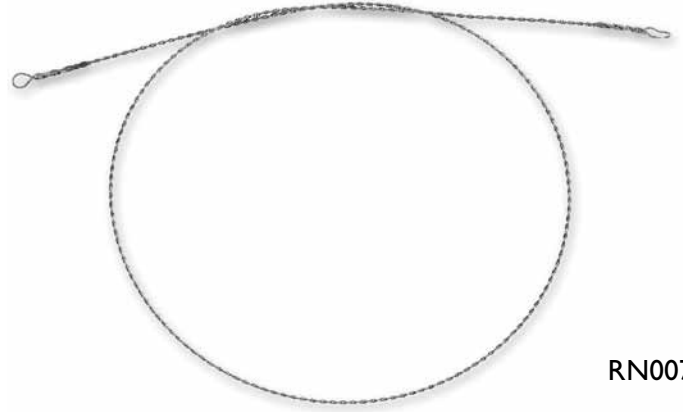

RN0070

Gigli Saw Guide

Catalog#	Description	Length
RN0061	Straight	12" (305mm)
RN0062	Curved	12" (305mm)



RN0062

Raney Saw Guide

Catalog#	Description	Length
RBI063	Curved	9" (229mm)



RBI063

Crile Ganglion Knife

Catalog#	Length
R0250	8½" (216mm)



Early Spinal Fusion Knife

Catalog#	Length	Tip Length
R0515	9" (229mm)	3.5mm



Paine's Carpal Tunnel Retinaculotome

Catalog#	Length
R0520	5¼" (133mm)



Ruggles Retinaculotome

Catalog#	Length
R0521	7" (178mm)





Adson Dura Hook

Catalog#	Description	Length
RN0120	Sharp	8" (203mm)
RN0121	Blunt	8" (203mm)



RN0120

Sachs Dura Hook

Catalog#	Length
R0200	6" (152mm)



R0200

Cushing Dura Hook

Catalog#	Length
R0205	5 3/8" (137mm)



R0205

Frazier Dura Hook

Catalog#	Length
R0210	4 7/8" (124mm)



R0210

Lahey Clinic Dura Hook

Catalog#	Length
R0212	5 1/4" (133mm)



R0212

Strully Dura Twist Hook

The Strully Dura Twist Hook is a simple and effective means of catching and holding the dura. The hook is placed against the dura and a half turn seats the point in the dura securely with little effort. The hook is used in a comfortable vertical plane which is particularly useful when approaching the dura through a small defect.

Catalog#	Length
R0215	6 1/4" (159mm)



R0215

Endonasal Pituitary Hook

Catalog#	Description
RN602I	45° Angled



RN602I





Dandy Nerve Hook

Catalog#	Description	Length
R0860	Straight	9" (229mm)
R0861	Left	8 ³ / ₄ " (222mm)
R0862	Right	8 ³ / ₄ " (222mm)



Hoer Nerve Hook

Catalog#	Description	Length
RN0123	Straight	9" (229mm)
RN0124	Left	8 ³ / ₄ " (222mm)



Murphy Ball Hook

Catalog#	Length	Diameter
R0848	8" (203mm)	2.5mm
RN0128	9" (229mm)	2.5mm



Cushing Gasserian Ganglion Hook

Catalog#	Description	Length
RB1109	Blunt	9" (229mm)



Smithwick Button Hook

Catalog#	Description	Length
RB1110	Blunt	8 ¹ / ₄ " (210mm)



Sachs Dura Separator and Guard

Catalog#	Length
R0225	9" (229mm)



R0225

Dorsey Dura Separator

Catalog#	Length	Width
R0231	6" (152mm)	5mm



R0231

Double Ended Dura Separator

Catalog#	Length	Width
R0233	5¾" (146mm)	3.5mm



R0233

Hoehn Dura Separator

Catalog#	Length	Angle
R0235	6½" (165mm)	45°
R0236	6¼" (159mm)	90°



R0235



R0236

Horsley Dura Separator and Guard

Catalog#	Description	Length	Tip Width
R0248	Angled	7" (178mm)	7mm



R0248

Sachs Dura Separator

Catalog#	Length	Tip Width
RN0210	9" (229mm)	6.5mm



RN0210

Frazier Dura Separator

Catalog#	Blade	Length	Tip Width
RN0211	Tapered	6½" (165mm)	3mm



RN0211

Sachs Nerve Root Separator

Catalog#	Length	Tip Width
RBI322	7¾" (197mm)	2.5mm



RBI322



Olivecrona Double Ended Dissector

Catalog#	Description	Length	Tip Width	Tip Width
R0175	Heavy	7¾" (197mm)	5mm	4mm
R0176	Light	7" (178mm)	3mm	2.5mm
R0177	Heavy	9½" (241mm)	5mm	4.5mm
R0178	Light	9½" (241mm)	3mm	2.5mm



R0177

Davis Nerve Separator and Spatula

Catalog#	Description	Length
R0240	Semi-Sharp	7¾" (197mm)



R0240

Freer Elevator

Catalog#	Description	Length	Tip Width	Tip Width
R0243	Sharp/Blunt Full Curve	8¼" (210mm)	6mm	6.5mm



R0243

Freer Double Ended Dissector

Catalog#	Length	Tip Width	Tip Width
R0244	7¾" (197mm)	5mm	5mm



R0244

Sachs Nerve Separator and Spatula

Catalog#	Description	Length	Tip Width
R0245	Slender	7 ³ / ₄ " (197mm)	2.5mm



R0245

Presbyterian Hospital Staphylorrhaphy Elevator

Catalog#	Description	Length	Tip Width	Tip Width
R0246	Straight	7 ¹ / ₄ " (184mm)	3.5mm	4.5mm
R0247	Curved	7 ¹ / ₄ " (184mm)	4mm	3.5mm



R0247

Davis Spatula

Catalog#	Length	Tip Width
R0252	6 ¹ / ₄ " (159mm)	5mm



R0252

Double Ended Dissector

Catalog#	Length	Tip Width	Tip Width
RN0410	8 ¹ / ₂ " (216mm)	6mm	8mm
R0259	8 ³ / ₄ " (222mm)	7mm	7mm



R0259



Penfield Dura Dissector

Catalog#	Style	Length
RN0401	#1	7 1/4" (184mm)
RN0402	#2	7 1/4" (184mm)
RN0403	#3	7 1/4" (184mm)
RN0404	#4	8" (203mm)
RN0405	#5	11 1/4" (286mm)



RN0401



RN0402



RN0403



RN0404



RN0405



Woodson Elevator and Spatula

Catalog#	Length	Tip Width	Tip Width
RN0222	10" (254mm)	3mm	3.5mm



RN0222

Woodson Elevator

Catalog#	Length	Tip	Tip
R0265	7¼" (184mm)	11.5 × 3.5mm	11 × 2.5mm



R0265

Woodson Dura Separator and Packer

Catalog#	Length	Tip Width	Tip Width
RN0413	7" (178mm)	3mm	3mm



RN0413

Woodson Double Ended Packer

Catalog#	Length	Tip Width	Tip Width
R0267	6¾" (171mm)	4mm	4.5mm



R0267

Oldberg Dissector

Catalog#	Length	Tip Width
R0268	7" (178mm)	5.5mm



R0268



Adson Elevator

Catalog#	Style	Description	Length	Tip Width
R0260	#1	Sharp, Straight Edge	6¾" (171mm)	9.5mm
R0261	#2	Curved, Semi-Sharp	6¾" (171mm)	6.5mm
R0262	#3	Curved, Blunt	6¾" (171mm)	7mm
R0263	#4	Straight, Semi-Sharp	6¾" (171mm)	7mm



R0260



R0261



R0262



R0263

Love-Adson Elevator

Catalog#	Length	Tip Width
R0295	6½" (165mm)	5mm



R0295



Cushing Periosteal Elevator

Catalog#	Description	Length	Tip Width
R0289	Rounded Edge, Serrated	7¼" (184mm)	16mm
R0290	Rounded Edge, Sharp	7¼" (184mm)	16mm
R0291	Square Edge, Sharp	7¼" (184mm)	16mm



R0291



R0290



R0289

Cushing Periosteal Elevator

Catalog#	Description	Length	Tip Width
R0285	Left	7¾" (197mm)	5mm
R0286	Right	7¾" (197mm)	5mm



R0285

Cushing Little Joker

Catalog#	Length	Tip Width
R0256	6" (152mm)	7mm
RN0506	7½" (191mm)	6.5mm



R0256

Joseph Periosteal Elevator

Catalog#	Length	Tip Width
R0269	6½" (165mm)	6mm



R0269

Key Periosteal Elevator

Catalog#	Length	Tip Width
R0270	6¾" (171mm)	⅛" (3mm)
R0271	6¾" (171mm)	¼" (6mm)
R0272	7¼" (184mm)	⅜" (10mm)
R0273	7¼" (184mm)	½" (13mm)
R0274	7½" (191mm)	⅝" (16mm)
R0275	8" (203mm)	¾" (19mm)
R0276	8½" (216mm)	1" (25mm)



Side view, close-up of R0271



R0271



R0272



R0273



R0275



R0276



Cobb Elevator

Hexagonal Handle

Catalog#	Length	Tip Width
RBI543	9½" (241mm)	⅜" (10mm)
RBI544	9½" (241mm)	½" (13mm)
RBI545	9½" (241mm)	¾" (19mm)
RBI546	9½" (241mm)	1" (25mm)
RBI547	9½" (241mm)	1¼" (32mm)



RBI546

Hoen Periosteal Elevator

Catalog#	Length	Tip Width
R0277	7¼" (184mm)	7.5mm
R0278	7½" (191mm)	15mm
R0279	7½" (191mm)	21mm



R0278

Langenbeck Periosteal Elevator

Catalog#	Description	Length	Tip Width
R0280	Narrow	8" (203mm)	6.5mm
R0281	Wide	7¾" (197mm)	18mm



R0280



R0281

Sedillot Elevator

Catalog#	Length	Tip Width
R0287	7½" (191mm)	18mm



R0287

Ballenger Septum Elevator

Catalog#	Length	Tip Width
RN0335	8¾" (222mm)	3mm



Cottle Septum Elevator

Catalog#	Description	Tip Width
RN0326	Double Ended, Graduated	4mm



John Day Periosteal Elevator

Catalog#	Description	Length	Tip Length
R8906	Straight	8" (203mm)	6mm
R8907	Angled with Cup	8" (203mm)	6mm
R8908	Angled 1cm from Cup	8" (203mm)	6mm
R8909	Straight	8¼" (210mm)	12mm



T. Fukushima Periosteal Elevator

Adson Type

Catalog#	Description	Length	Tip Width
R8914	Slight Curve	7¼" (184mm)	7mm
R8915	Regular Curve	7¼" (184mm)	7mm
R8913	Modified Langenbeck	7¾" (197mm)	13mm



T. Fukushima Dural Elevator and Spatula

Double Ended

Catalog#	Description	Length	Tip Width	Tip Width
R8911	Double Ended	8 1/4" (210mm)	5mm	4mm
R8912	Double Ended, Reduced	8 1/4" (210mm)	2mm	2mm



R8911



R8912

Cobb Spinal Elevator

Catalog#	Length	Width
R0294	11" (279mm)	3/8" (10mm)
R0296	11" (279mm)	1/2" (13mm)
R0297	11" (279mm)	3/4" (19mm)
R0298	11" (279mm)	1" (25mm)
R0299	11" (279mm)	1 1/4" (32mm)



Side view, close-up of R0294



R0297

Lambotte Osteotome

Straight

Catalog#	Length	Width
RBI473	5" (127mm)	4mm
RBI474	5" (127mm)	6mm
RBI475	5" (127mm)	8mm
RBI476	5" (127mm)	10mm
RBI477	5" (127mm)	12mm
RBI478	5" (127mm)	14mm
RBI479	5" (127mm)	15mm
RBI480	5" (127mm)	18mm
RBI481	5" (127mm)	19mm
RBI482	5" (127mm)	20mm
RBI453	7 1/4" (184mm)	4mm
RBI454	7 1/4" (184mm)	5mm
RBI455	7 1/4" (184mm)	6mm
RBI456	7 1/4" (184mm)	8mm
RBI457	7 1/4" (184mm)	10mm
RBI458	7 1/4" (184mm)	12mm
RBI459	7 1/4" (184mm)	16mm
RBI460	7 1/4" (184mm)	19mm
RBI461	7 1/4" (184mm)	22mm
RBI462	7 1/4" (184mm)	25mm
R2200	9" (229mm)	1/4" (6mm)
R2201	9" (229mm)	1/2" (13mm)
R2202	9" (229mm)	3/4" (19mm)
R2203	9" (229mm)	1" (25mm)
R2204	9" (229mm)	1 1/4" (32mm)
R2205	9" (229mm)	1 1/2" (38mm)

Curved

Catalog#	Length	Width
RBI483	5" (127mm)	4mm
RBI484	5" (127mm)	6mm
RBI485	5" (127mm)	8mm
RBI486	5" (127mm)	10mm
RBI487	5" (127mm)	12mm
RBI488	5" (127mm)	14mm
RBI489	5" (127mm)	15mm
RBI490	5" (127mm)	18mm
RBI491	5" (127mm)	19mm
RBI492	5" (127mm)	20mm
RBI463	7 1/4" (184mm)	4mm
RBI464	7 1/4" (184mm)	5mm
RBI465	7 1/4" (184mm)	6mm
RBI466	7 1/4" (184mm)	8mm
RBI467	7 1/4" (184mm)	10mm
RBI468	7 1/4" (184mm)	12mm
RBI469	7 1/4" (184mm)	16mm
RBI470	7 1/4" (184mm)	19mm
RBI471	7 1/4" (184mm)	22mm
RBI472	7 1/4" (184mm)	25mm
R2210	9" (229mm)	1/4" (6mm)
R2211	9" (229mm)	1/2" (13mm)
R2212	9" (229mm)	3/4" (19mm)
R2213	9" (229mm)	1" (25mm)
R2214	9" (229mm)	1 1/4" (32mm)
R2215	9" (229mm)	1 1/2" (38mm)



R2202



Straight



Curved

Smith-Peterson Osteotome

Catalog#	Description	Length	Width
R0300	Straight	8" (203mm)	1/4" (6mm)
R0301	Straight	8" (203mm)	3/8" (10mm)
R0302	Straight	8" (203mm)	1/2" (13mm)
R0303	Straight	8" (203mm)	5/8" (15mm)
R0304	Straight	8" (203mm)	3/4" (19mm)
R0305	Straight	8" (203mm)	1" (25mm)
R0306	Straight	8" (203mm)	1 1/4" (32mm)
R0310	Curved	8" (203mm)	1/4" (6mm)
R0311	Curved	8" (203mm)	3/8" (10mm)
R0312	Curved	8" (203mm)	1/2" (13mm)
R0313	Curved	8" (203mm)	5/8" (15mm)
R0314	Curved	8" (203mm)	3/4" (19mm)
R0315	Curved	8" (203mm)	1" (25mm)
R0316	Curved	8" (203mm)	1 1/4" (32mm)



R0305



R0315

Gerzog Bone Mallet

Catalog#	Description	Head	Length
RBI695	Lead Filled	1" (25mm)	6 3/4" (171mm)



RBI695



Smith-Peterson Gouge

Catalog#	Description	Length	Width
R2260	Straight	8" (203mm)	1/4" (6mm)
R2261	Straight	8" (203mm)	3/8" (10mm)
R2262	Straight	8" (203mm)	1/2" (13mm)
R2263	Straight	8" (203mm)	5/8" (15mm)
R2264	Straight	8" (203mm)	3/4" (19mm)
R2265	Straight	8" (203mm)	1" (24mm)
R2266	Straight	8" (203mm)	1 1/4" (32mm)
R2270	Curved	8" (203mm)	1/4" (6mm)
R2271	Curved	8" (203mm)	3/8" (10mm)
R2272	Curved	8" (203mm)	1/2" (13mm)
R2273	Curved	8" (203mm)	5/8" (15mm)
R2274	Curved	8" (203mm)	3/4" (19mm)
R2275	Curved	8" (203mm)	1" (24mm)
R2276	Curved	8" (203mm)	1 1/4" (32mm)



R2264



R2274

Cobb Type Gouge

Catalog#	Description	Length	Tip Width
R2240	Straight	11" (279mm)	7.5mm
R2241	Medium Curve	11" (279mm)	7.5mm
R2242	Strong Curve	11" (279mm)	7.5mm
R2243	Reverse Curve	11" (279mm)	7.5mm



R2240



R2241



R2242



R2243

Lumbar and Cervical Impactor

Catalog#	Description	Length	Tip Size
R6540	Standard Guarded	8½" (216mm)	7×12.5mm
R6541	Standard	8½" (216mm)	7×12.5mm
R6542	Wide Guarded	8½" (216mm)	10×13mm
R6543	Wide	8½" (216mm)	10×13mm
R6544	Offset	8½" (216mm)	6.5×11.5mm
R6545	Angled	8½" (216mm)	6.5×16mm
R6546	Narrow	8½" (216mm)	6.5×12.5mm
R6547	Micro, Offset	7" (178mm)	4.3×10mm
R6548	Micro, Lateral	7" (178mm)	4.3×10mm



Long Bone Graft Impactor



R12168

Catalog#	Length	Tip Width
R12164	14" (356mm)	8mm
R12165	14" (356mm)	9mm
R12166	14" (356mm)	10mm
R12167	14" (356mm)	11mm
R12168	14" (356mm)	12mm
R12169	14" (356mm)	13mm
R12170	14" (356mm)	14mm
R12171	14" (356mm)	15mm

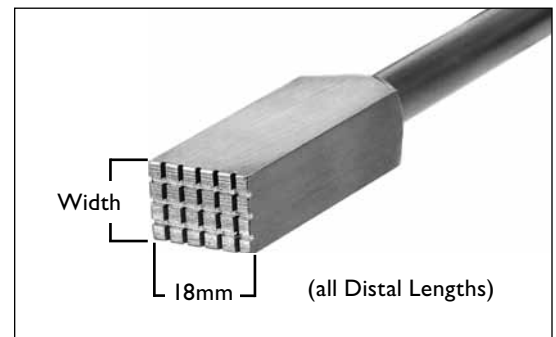



RETRACTORS

ACF Complete System

Catalog#	Description
----------	-------------

R6000 Ruggles™ ACF Complete System with Sterilization Tray

Includes (1) each of following: R6298, R6310, R6312, R6313, R6314, R6315, R6316, R6317, R6318, R6319, R6320, R6321, R6337, R6370, R6371, R6372, R6373, R6374, R6375, R6376, R6377, R6378, R6379, R6381, R6382, R6383, R6384, R6385, R6387, R6388, R6389, R6390, R6391, R6392, R6393, R6394, R6396, R6399, RN2877, RN2878, RN2879 and (2) each of R9395

Drill Guide

Catalog#	Description
----------	-------------

R6388 Left

R6393 Right



R6388

Distractor

Catalog#	Description	Ratchet Bar Length
----------	-------------	--------------------

R6387 Single Level, Left 4" (100mm)

R6389 Multiple Level, Left 4¾" (120mm)

R6392 Single Level, Right 4" (100mm)

R6394 Multiple Level, Right 4¾" (120mm)



R6387

Screwdriver

Catalog#	Length
----------	--------

R6396 8" (205mm)



R6396

Twist Drill

Catalog#	Length	Bit Length
----------	--------	------------

R9395 5¼" (133mm) 8mm



R9395

Distraction Screws

Catalog#	Description	Tip Length
----------	-------------	------------

RN2877 Non-Sterile 12mm

RN2878 Non-Sterile 14mm

RN2879 Non-Sterile 16mm

R6367A Sterile 12mm

R6398A Sterile 14mm

R6397A Sterile 16mm



R9395

Transverse Retractor

Catalog#	Description	Spread
R6312	Transverse Retractor Body	5 ³ / ₈ " (137mm)

Longitudinal Retractor

Catalog#	Description
R6313	Longitudinal Retractor Body

Medial Retractor Blades, Ball Snap

Long Teeth

Catalog#	Description	Size
R6555	Short Length	25 × 23mm
R6556	Short Length	30 × 23mm
R6557	Short Length	35 × 23mm
R6370	Medium Length	40 × 23mm
R6371	Medium Length	45 × 23mm
R6372	Medium Length	50 × 23mm
R6373	Medium Length	55 × 23mm
R6374	Medium Length	60 × 23mm
R6558	Long Length	65 × 23mm
R6559	Long Length	70 × 23mm

Longitudinal Retractor Blades, Ball Snap

Blunt

Catalog#	Description	Size
R6550	Short Length	30 × 23mm
R6551	Short Length	35 × 23mm
R6552	Short Length	40 × 23mm
R6381	Medium Length	45 × 23mm
R6382	Medium Length	50 × 23mm
R6383	Medium Length	55 × 23mm
R6384	Medium Length	60 × 23mm
R6385	Medium Length	65 × 23mm
R6553	Long Length	70 × 23mm
R6554	Long Length	75 × 23mm

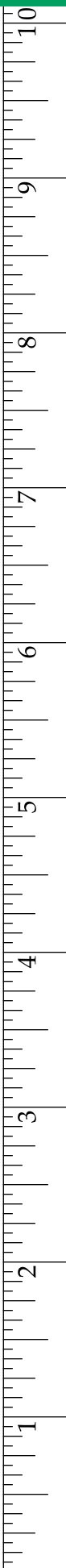
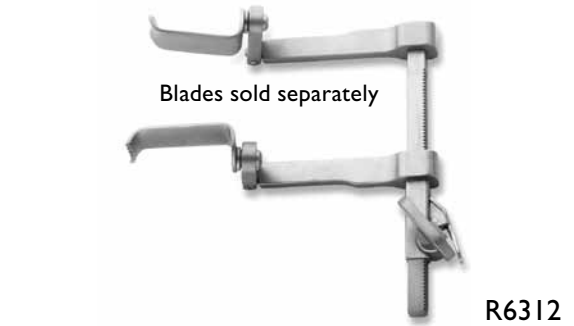



Lateral Retractor Blades, Ball Snap

Short Teeth

Catalog#	Description	Size
R6560	Short Length	25 × 23mm
R6561	Short Length	30 × 23mm
R6562	Short Length	35 × 23mm
R6375	Medium Length	40 × 23mm
R6376	Medium Length	45 × 23mm
R6377	Medium Length	50 × 23mm
R6378	Medium Length	55 × 23mm
R6379	Medium Length	60 × 23mm
R6563	Long Length	65 × 23mm
R6564	Long Length	70 × 23mm



R6564

Fenestrated Iliac Blades, Ball Snap

Catalog#	Size
R6320	50 × 23mm
R6321	60 × 23mm



R6321

Blade Ejector

Catalog#
R6310



R6310

Cloward Style Depth Gauge

Catalog#	Length
RB2375	7" (178mm)



RB2375

Caliper

Catalog#	Length
R6317	8" (203mm)

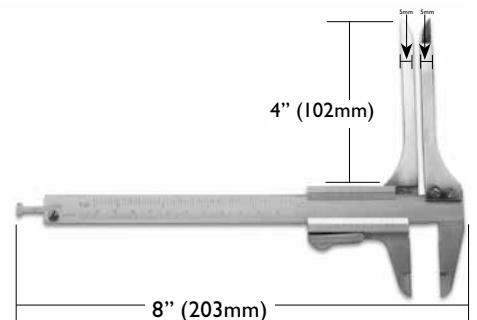

R6317

Bone Graft Harvesting Forceps

Catalog#	Length	Width
R6318	8 3/4" (222mm)	9mm
R6319	8 3/4" (222mm)	7mm



R6318

Bone Graft Impactor

Catalog#	Length	Diameter
R6314	7 3/4" (197mm)	3mm
R6315	7 3/4" (197mm)	5mm
R6316	7 3/4" (197mm)	8mm



Bone Graft Holder

Catalog#
R6399



R6399

Vertebral Body Dissector

Catalog#	Description
R6390	Small
R6391	Large
R6337	Micro



R6391

Anterior Cervical Fusion Tray

Catalog#
R6298

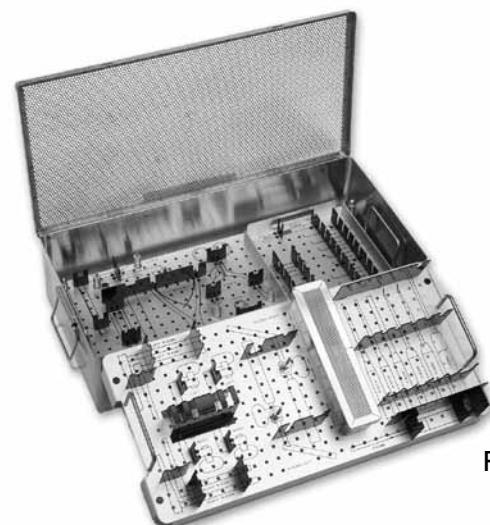

R6298



Carbon Fiber Retractor Blades, Radiolucent (not pictured)

Catalog#	Body	Teeth
RB2471	40 × 23mm	Long
RB2472	45 × 23mm	Long
RB2473	50 × 23mm	Long
RB2474	55 × 23mm	Long
RB2475	60 × 23mm	Long
RB2481	40 × 23mm	Short
RB2482	45 × 23mm	Short
RB2483	50 × 23mm	Short
RB2484	55 × 23mm	Short
RB2485	60 × 23mm	Short

Catalog#	Body	Teeth
RB2491	40 × 23mm	Blunt
RB2492	45 × 23mm	Blunt
RB2493	50 × 23mm	Blunt
RB2494	55 × 23mm	Blunt
RB2495	60 × 23mm	Blunt

Carbon Fiber Retractor Blade Sets

Catalog#	Set Includes	Teeth
RB2470	RB2471 – RB2475	Long
RB2480	RB2481 – RB2485	Short
RB2490	RB2491 – RB2495	Blunt

MLD Retractor Set

Catalog#	Description
R6406	Complete Set Includes: one (1) MLD Retractor Body six (6) MLD Center Blades

MLD Retractor

Catalog#	Description	Spread
R6405	MLD Retractor Body	4½" (114mm)



R6405

MLD Center Retractor Blades, Ball Snap

Catalog#	Size
R6407	35 × 14mm
R6408	40 × 14mm
R6409	45 × 14mm
R6410	50 × 14mm
R6411	55 × 14mm
R6412	60 × 14mm



R6412

Blade Ejector

Catalog#
R6310



R6310

Speculum Retractor

Catalog#	Blade Length
R6413	40mm
R6414	45mm
R6415	50mm
R6416	55mm
R6417	60mm
R6418	65mm



R6418



UMLD Scoville Retractor

Double Hinged

Catalog#	Description
R6579	Scoville Retractor Body



R6579

UMLD Retractor Blades

Catalog#	Size
R6630	50 × 10mm
R6631	60 × 10mm
R6632	50 × 20mm
R6633	60 × 20mm
R6601	65 × 14mm
R6602	70 × 14mm
R6603	75 × 14mm
R6604	80 × 14mm



R6630



R6604

Blade Ejector

Catalog#
R6310



R6310

UMLD Scoville Blades, Ball Snap

Catalog#	Size
R6641	40 × 38mm
R6644	67 × 32mm



R6641

UMLD Taylor Blades, Ball Snap

Catalog#	Size
R6643	40 × 51mm
R6640	44 × 38mm
R6642	63 × 57mm



R6640

UMLD Hooks, Ball Snap

Catalog#	Size
R6621	50mm
R6622	60mm



R6621

UMLD T-Bars, Ball Snap

Catalog#	Size
R6623	50mm
R6624	60mm



R6623

Flexi-Spine™ Retraction System

With multiple blade and retractor options, the Ruggles™ Flex-Spine™ Retractor System is used for single-level and multi-level procedures in cervical fusion and microlumbar discectomy cases. The system remains secure during surgical procedures and is designed for easy identification, insertion, and retraction.

Catalog#	Description
RU2400	Complete Set Includes: two (2) retractor handles two (2) retractor bodies one (1) instrument tray all blade pairs and hooks

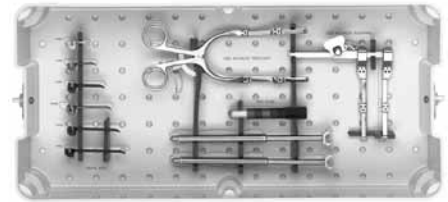
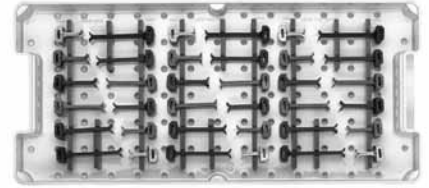

Flexi-Spine™ Instrument Tray

Catalog#
RS2400

RU2400

Transverse Retractor Body

Catalog#
RU2408



RU2408

Longitude Retractor Body

Catalog#
RU2409

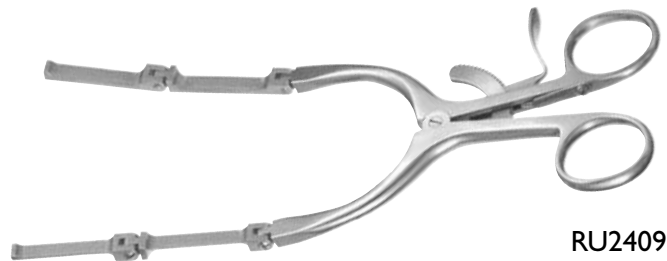

RU2409

Depth Gauge

Catalog#
RU2422



RU2422



Retractor Blade Handle

Catalog#

RU2403



RU2403

RU2404 Short Teeth Blade Set (12 pair)

Catalog#	Color	Size
RU2410	Silver	15 × 25mm
RU2411	Blue	15 × 35mm
RU2412	Red	15 × 45mm
RU2413	Green	15 × 55mm
RU2414	Purple	15 × 65mm
RU2415	Black	15 × 75mm

Catalog#	Color	Size
RU2416	Silver	20 × 25mm
RU2417	Blue	20 × 35mm
RU2418	Red	20 × 45mm
RU2419	Green	20 × 55mm
RU2420	Purple	20 × 65mm
RU2421	Black	20 × 75mm



RU2405 Blunt Blade Set (12 pair)

Catalog#	Color	Size
RU2446	Silver	15 × 25mm
RU2447	Blue	15 × 35mm
RU2448	Red	15 × 45mm
RU2449	Green	15 × 55mm
RU2450	Purple	15 × 65mm
RU2451	Black	15 × 75mm

Catalog#	Color	Size
RU2452	Silver	20 × 25mm
RU2453	Blue	20 × 35mm
RU2454	Red	20 × 45mm
RU2455	Green	20 × 55mm
RU2456	Purple	20 × 65mm
RU2457	Black	20 × 75mm



RU2406 Long Teeth Blade Set (12 pair)

Catalog#	Color	Size
RU2428	Silver	15 × 25mm
RU2429	Blue	15 × 35mm
RU2430	Red	15 × 45mm
RU2431	Green	15 × 55mm
RU2432	Purple	15 × 65mm
RU2433	Black	15 × 75mm

Catalog#	Color	Size
RU2434	Silver	20 × 25mm
RU2435	Blue	20 × 35mm
RU2436	Red	20 × 45mm
RU2437	Green	20 × 55mm
RU2438	Purple	20 × 65mm
RU2439	Black	20 × 75mm



RU2407 Hook Set (6 hooks)

Catalog#	Color	Size
RU2464	Silver	18mm
RU2465	Blue	28mm
RU2466	Red	38mm

Catalog#	Color	Size
RU2467	Green	48mm
RU2468	Purple	58mm
RU2469	Black	68mm





Spinal Retraction System

Catalog# Description

RN2800 Complete Set Includes: two (2) retractor handles
two (2) retractor bodies
one instrument tray
all 15mm and 20mm blade pairs and hooks



RN2800

Spinal Retractor System Tray

Catalog#

RS2800

Transverse Retractor Body

Catalog# Length

RN2801 5 ¼" (133mm)

Blades sold separately



RN2801

Longitudinal Retractor Body

Catalog#

RN2802

Blades sold separately



RN2802

Retractor Blade Handle

Catalog# Length

RN2803 7 ¼" (184mm)



RN2803

Short Teeth Blade (pair)

Black

Catalog#	Size
RN28110	15 × 25mm
RN28111	15 × 35mm
RN28112	15 × 45mm
RN28113	15 × 55mm
RN28114	15 × 65mm
RN28115	15 × 75mm

Catalog#	Size
RN28116	20 × 25mm
RN28117	20 × 35mm
RN28118	20 × 45mm
RN28119	20 × 55mm
RN28120	20 × 65mm
RN28121	20 × 75mm

Optional Blades (pair)

not included in the set

Catalog#	Size
RN28122	30 × 25mm
RN28123	30 × 35mm
RN28124	30 × 45mm
RN28125	30 × 55mm
RN28126	30 × 65mm
RN28127	30 × 75mm

Long Teeth Blade (pair)

Black

Catalog#	Size
RN28210	15 × 25mm
RN28211	15 × 35mm
RN28212	15 × 45mm
RN28213	15 × 55mm
RN28214	15 × 65mm
RN28215	15 × 75mm

Catalog#	Size
RN28216	20 × 25mm
RN28217	20 × 35mm
RN28218	20 × 45mm
RN28219	20 × 55mm
RN28220	20 × 65mm
RN28221	20 × 75mm

Catalog#	Size
RN28222	30 × 25mm
RN28223	30 × 35mm
RN28224	30 × 45mm
RN28225	30 × 55mm
RN28226	30 × 65mm
RN28227	30 × 75mm

Blunt Blade (pair)

Black

Catalog#	Size
RN28310	15 × 25mm
RN28311	15 × 35mm
RN28312	15 × 45mm
RN28313	15 × 55mm
RN28314	15 × 65mm
RN28315	15 × 75mm

Catalog#	Size
RN28316	20 × 25mm
RN28317	20 × 35mm
RN28318	20 × 45mm
RN28319	20 × 55mm
RN28320	20 × 65mm
RN28321	20 × 75mm

Catalog#	Size
RN28322	30 × 25mm
RN28323	30 × 35mm
RN28324	30 × 45mm
RN28325	30 × 55mm
RN28326	30 × 65mm
RN28327	30 × 75mm

Hooks (each)

Black

Catalog#	Size
RN28410	18mm
RN28411	28mm
RN28412	38mm
RN28413	48mm
RN28414	58mm
RN28415	68mm

Note: Unannodized versions available for Europe and Canada with "EU" at end of catalog number.

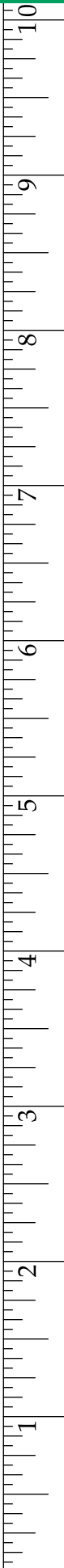

LumbarTrak™ Retractor System

The LumbarTrak™ Retraction System is flexible enough to be used for many lumbar and thoracic spinal procedures from microdiscectomies to multilevel fusions. The retractor blades are made of titanium which is lighter and more radiolucent than stainless steel.

Catalog#	Description
RB2600	<p>Lumbar Retractor System Includes:</p> <p>One each of: RB2601B, RB2602, RB2606, RBT2600</p> <p>Two each of: RB2605, RB2620–RB2633, RB2640–RB2648</p> <p>Four each of: RB2603–RB2604, RB2610–RB2617</p>

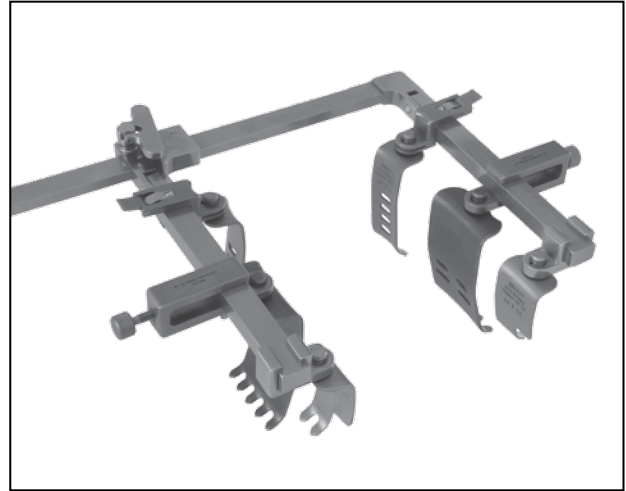

LumbarTrak™ Square Retractor

Stainless Steel

Catalog#
RB2601B

LumbarTrak™ Scoville Retractor

Titanium

Catalog#
RB2602

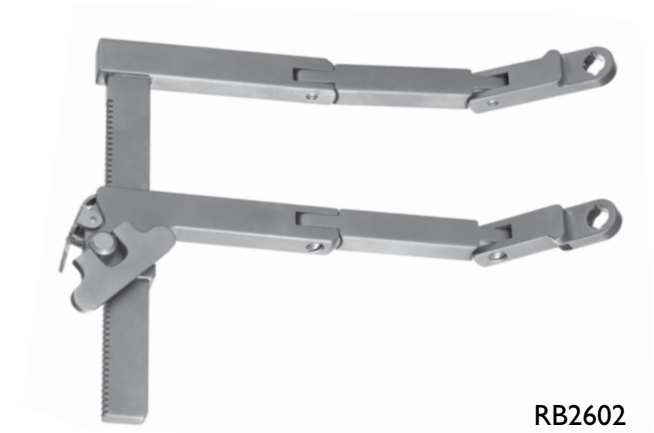

RB2602

LumbarTrak™ Quick Connector

Titanium

Catalog#

RB2603



LumbarTrak™ Long Connector

Titanium

Catalog#

RB2604



RB2604

LumbarTrak™ Handle

Catalog#

RB2605



RB2605

*Blades sold separately

LumbarTrak™ Titanium Depth Gauge

Catalog# Description

RB2606 Color Coded



RB2606

LumbarTrak™ Blade Popper

Catalog#

RB2609



RB2609



LumbarTrak™ Thin Blades

Titanium

Catalog#	Color	Blade
RB2610	Purple	24 × 30mm
RB2611	Light Blue	24 × 40mm
RB2612	Green	24 × 50mm
RB2613	Pink	24 × 60mm
RB2614	Dark Blue	24 × 70mm
RB2615	Gold	24 × 90mm
RB2616	Purple	24 × 110mm
RB2617	Light Blue	24 × 130mm
RB2618	Silver	24 × 80mm

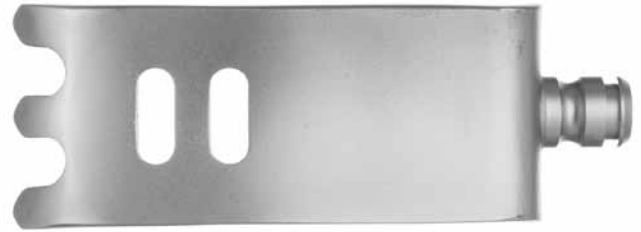

LumbarTrak™ Medium Blades

Titanium

Catalog#	Color	Blade
RB2621	Green	45 × 50mm
RB2623	Pink	45 × 60mm
RB2625	Dark Blue	45 × 70mm
RB2627	Gray	45 × 80mm
RB2629	Gold	45 × 90mm
RB2631	Purple	45 × 110mm
RB2633	Light Blue	45 × 130mm

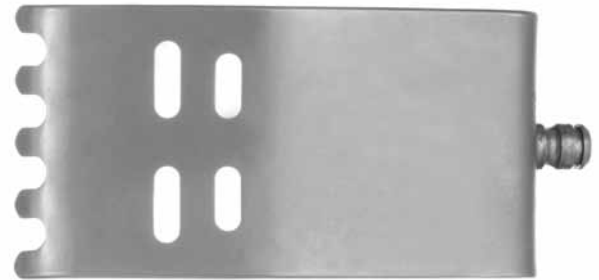

LumbarTrak™ Wide Blades

Titanium

Catalog#	Color	Blade
RB2620	Green	60 × 50mm
RB2622	Pink	60 × 60mm
RB2624	Dark Blue	60 × 70mm
RB2626	Gray	60 × 80mm
RB2628	Gold	60 × 90mm
RB2630	Purple	60 × 110mm
RB2632	Light Blue	60 × 130mm

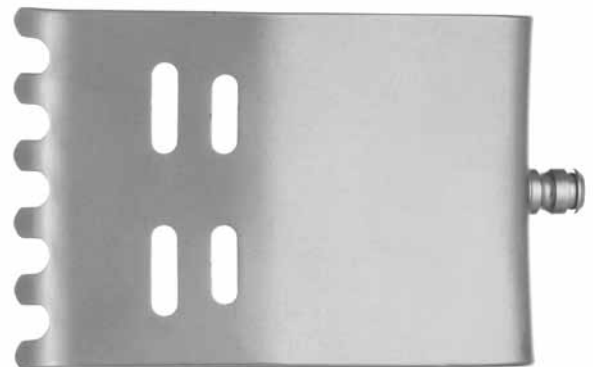

LumbarTrak™ Hook

Titanium

Catalog#	Color	Blade
RB2640	Light Blue	42mm
RB2641	Green	52mm
RB2642	Pink	62mm
RB2643	Dark Blue	72mm
RB2644	Gold	92mm



LumbarTrak™ Sacral Blade

Titanium

Catalog#	Body	Color	Blade
RB2645	30 × 40mm	Light Blue	Left
RB2646	60 × 45mm	Green	Left
RB2647	30 × 40mm	Light Blue	Right
RB2648	60 × 45mm	Green	Right



LumbarTrak™ Tray

Catalog#

RBT2600

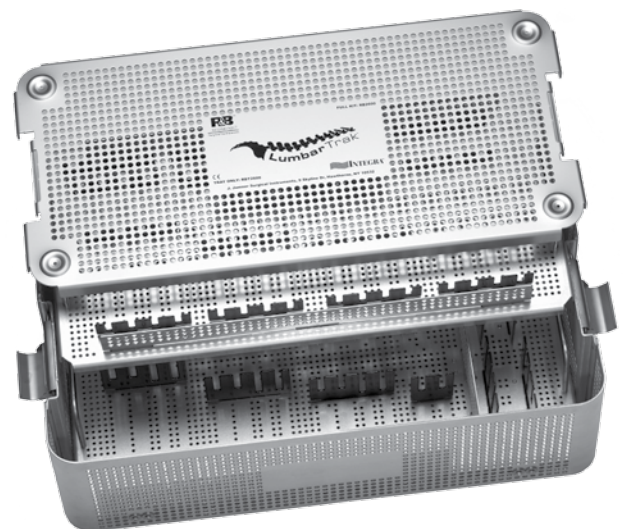

RBT2600

Spetzler Sonntag Trans-Oral Retractor System

- Improved design for better exposure
- Totally self-retaining
- Complete retraction by secure mounting to mouth gag
- Assembles to table rail for ease of use and stability
- Positions easily in the optimum orientation
- Full line of retractor styles and sizes
- 3 sizes of slotted and non-slotted tongue depressors
- 3 sizes of palate retractors
- 2 sizes of lateral retractors

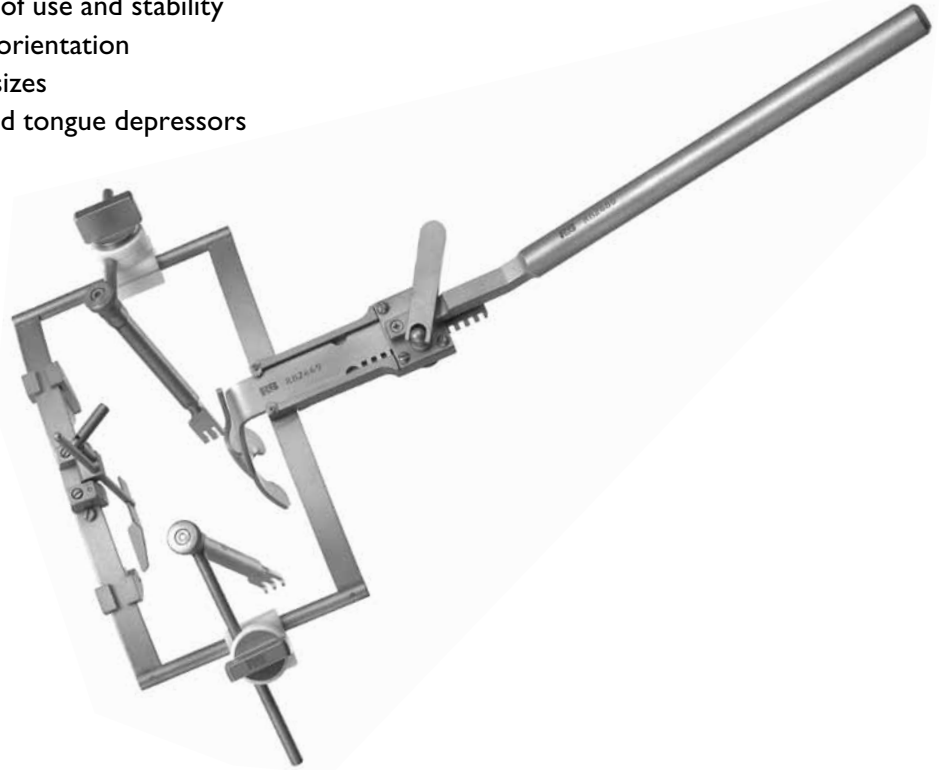

Catalog#	Description
RB2660	Spetzler Sonntag Trans-Oral Retractor System Includes: One each of RB2661–RB2680 One each of RB2664 One each of RB2671 One each of RBT2660

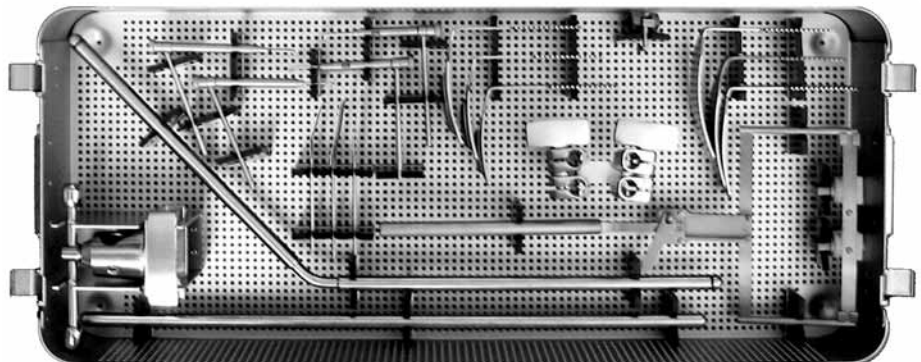

RB2660

Table Clamp (not pictured)

Catalog#

RB2661

Mounting Arm

Catalog# Description

RB2662 Straight

RB2663 Angled



RB2662



RB2663

Mounting Rod Clamp

Catalog#

RB2664



RB2664



Tongue Depressor

Catalog#	Description
RB2665	Short
RB2666	Medium
RB2667	Long



RB2665

Slotted Tongue Depressor with Suction Tube Slot

Catalog#	Width
RB2668	28mm
RB2669	35mm
RB2670	37mm



RB2668

Lateral Retractor

Catalog#	Description	Angle
RB2672	Short	Left
RB2673	Short	Right
RB2674	Long	Left
RB2675	Long	Right



RB2675

Palate Retractor

Catalog#	Description
RB2676	14mm
RB2677	21mm
RB2678	28mm

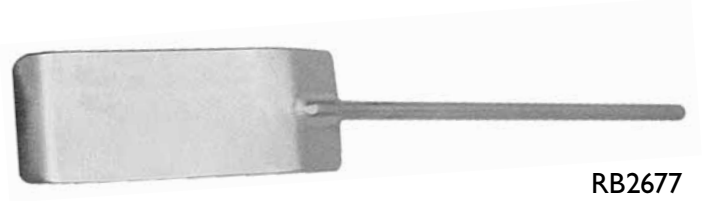

RB2677

Mouth Gag

Catalog# _____

RB2680

Lateral retractor clamps sold separately

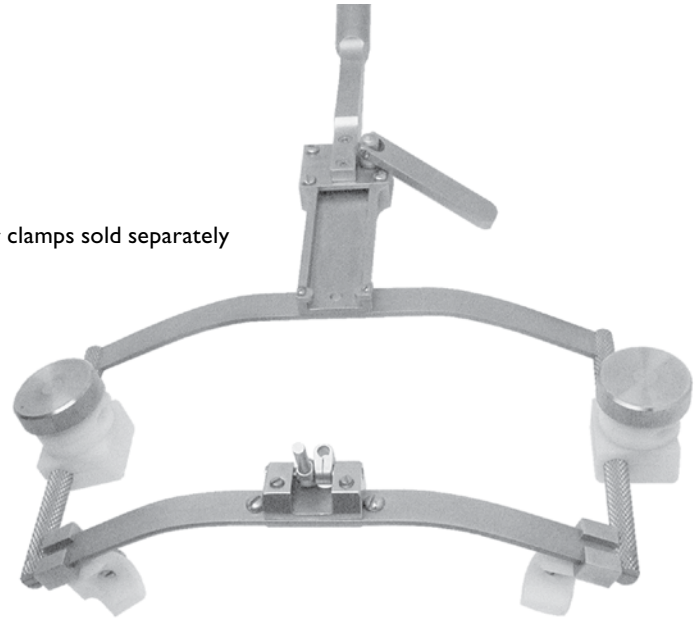

Lateral Retractor Clamp

Catalog# _____

RB2671



RB2671

Palate Retractor Clamp

Catalog# _____

RB2679



RB2679

Trans-Oral Retractor Tray (not pictured)

Catalog# _____

RBT2660

Spetzler Sonntag Trans-Oral Instruments Set

Catalog#	Description
RB2690	Spetzler Sonntag Trans-Oral Instrument Set Includes: One each of:
RB2656	Disc Dissector, 90°
RB2657	Disc Dissector, 45°
RB2658	Disc Dissector, 0°
RN5743H	Love-Gruenwald IVD, 7" (178mm)
RN5743HX	IVD with Teeth, 3mm, 7" (178mm)
R2800	Flatback Fusion Curette, 00000, Straight, 9" (229mm)
R2801	Flatback Fusion Curette, 0000, Straight, 9" (229mm)
R2820	Flatback Fusion Curette, 00000, 40°, 9" (229mm)
R2821	Flatback Fusion Curette, 0000, 40°, 9" (229mm)
R2840	Flatback Fusion Curette, 00000, 90°, 9" (229mm)
R2841	Flatback Fusion Curette, 0000, 90°, 9" (229mm)
RBT2690	Instrument Tray Two each of:
RBG4027	DeBakey Forceps, 9½" (242mm), Fine (2 in set)
RB2659	Pencil Grip Needle Holder, 17½" (445mm)

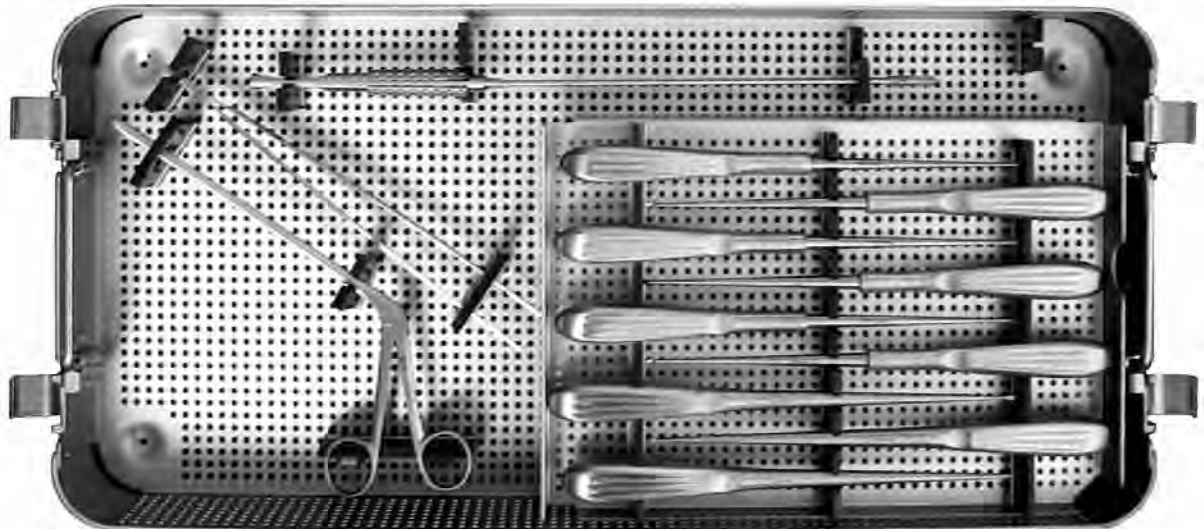

McCulloch Retractor Set

Catalog#	Description
RB2120	<p>Set consists of one each: One each of RB2121 One each of RB2123 to RB2126 One each of RB2129 to RB2132 One each of RB2141 to RB2144 One each of RB2148 to RB2151</p> <p>Tray not included. Set does not include shortest and longest of each blade and hook.</p>

McCulloch Retractor Body

Catalog#	Description
RB2121	Black, max opening 75mm

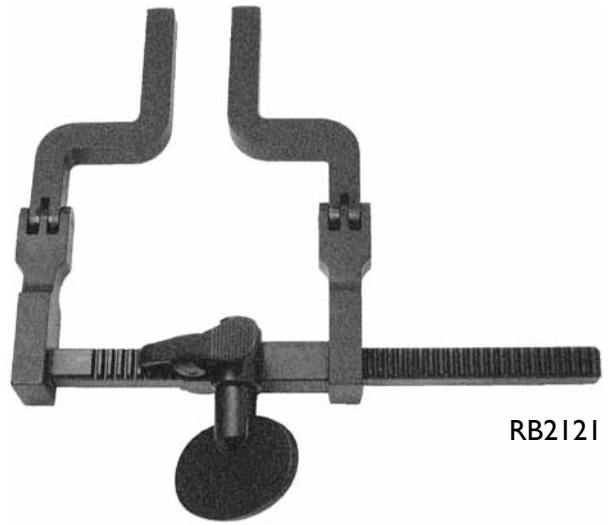

RB2121

McCulloch Retractor Tray

Catalog#
RBT2120

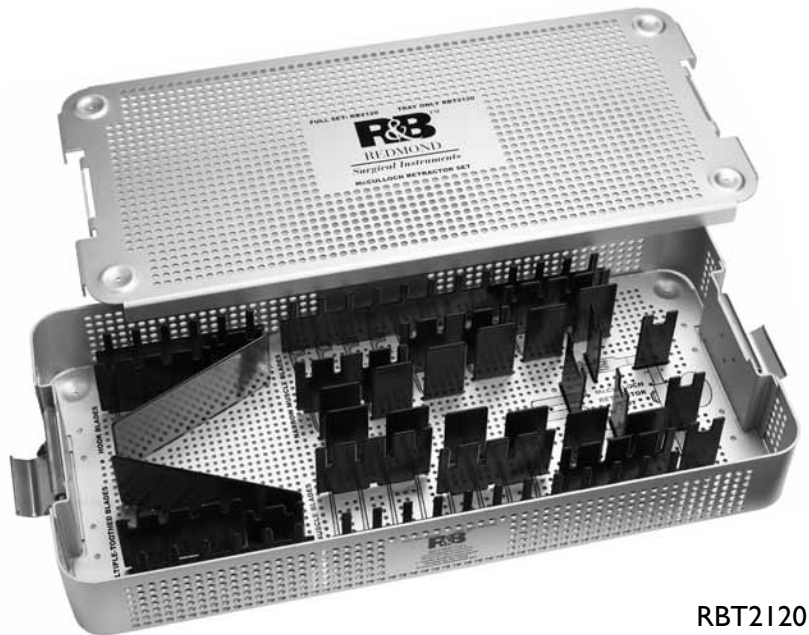

RBT2120



Narrow Muscle Blade (Pair)

Catalog#	Length	Width
RB2I22	30mm	20mm
RB2I23	40mm	20mm
RB2I24	50mm	20mm
RB2I25	60mm	20mm
RB2I26	70mm	20mm
RB2I27	80mm	20mm

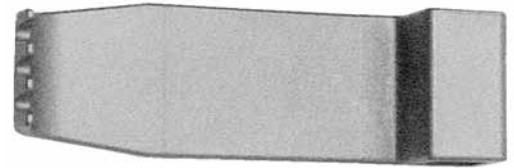

Wide Muscle Blade (Pair)

Catalog#	Length	Width
RB2I28	30mm	27mm
RB2I29	40mm	27mm
RB2I30	50mm	27mm
RB2I31	60mm	27mm
RB2I32	70mm	27mm
RB2I33	80mm	27mm

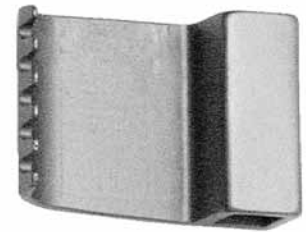

Hook Blades (Each)

Catalog#	Length
RB2I40	20mm
RB2I41	30mm
RB2I42	40mm
RB2I43	50mm
RB2I44	60mm
RB2I45	70mm



Multiple-Toothed Hooks (Each)

Catalog#	Length
RB2I47	20mm
RB2I48	30mm
RB2I49	40mm
RB2I50	50mm
RB2I51	60mm
RB2I52	70mm



Silicone Retractor

Clear Reinforced

Catalog#	Length	Body
NL7702701	5" (127mm)	76 × 9mm
NL7702702	5" (127mm)	76 × 13mm
NL7702703	5" (127mm)	76 × 11mm
NL7702704	5" (127mm)	76 × 22mm
NL7702705	4¾" (121mm)	70 × 15mm
NL7702707	5¾" (146mm)	95 × 20mm
NL7702708	4⅞" (124mm)	75 × 25mm

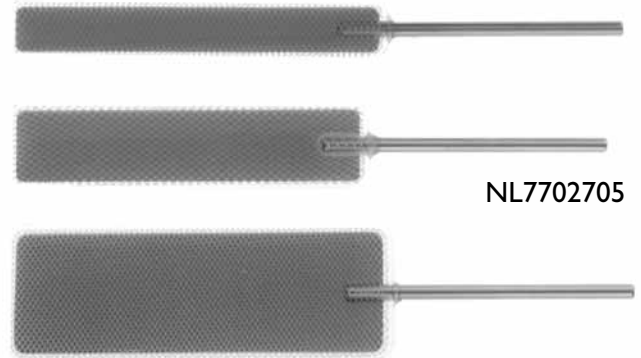

NL7702705

Hand-Held Silicone Retractor

Clear Reinforced

Catalog#	Length	Size
NL8700204	8" (203mm)	¼" (6mm)
NL8700206	8" (203mm)	⅜" (10mm)
NL8700208	8" (203mm)	½" (13mm)
NL8700210	8" (203mm)	⅝" (16mm)
NL8700214	8" (203mm)	⅞" (22mm)



NL8700208

NL8700200 Hand-Held Set (5)

Includes one each of items above



Silicone Retractor

Black with post

Catalog#	Style	Length	Blade
RN0711N	Narrow	6" (152mm)	6.5mm
RN0711W	Wide	6" (152mm)	10mm
RN0712N	Narrow	6" (152mm)	9mm
RN0712W	Wide	6" (152mm)	15mm
RN0713N	Narrow	6" (152mm)	11.5mm
RN0713W	Wide	6" (152mm)	20mm
RN0714N	Narrow	6" (152mm)	14mm
RN0714W	Wide	6" (152mm)	25.5mm



RN0713N



RN0714W

Hand-Held Silicone Retractor

Black

Catalog#	Style	Length	Size
RN0711	Small	6 3/4" (171mm)	6.5 × 10mm
RN0712	Narrow	6 3/4" (171mm)	9 × 15mm
RN0713	Large	6 3/4" (171mm)	11.5 × 20mm
RN0714	X-Large	6 3/4" (171mm)	14 × 25mm

RN0710 Hand-Held Set (4)

Includes one each of items above



RN0713



RN0714

Davis Spatula

Catalog#	Length	Width
R0924	7" (178mm)	¼" (6mm)
R0925	7" (178mm)	⅜" (10mm)
R0926	7" (178mm)	½" (13mm)
R0927	7" (178mm)	⅝" (16mm)
R0928	7" (178mm)	¾" (19mm)
R0929	7" (178mm)	⅞" (22mm)
R0930	7" (178mm)	1" (25mm)



R0924



R0925



R0930

Davis Spatula

Insulated, Blue Insulated Coating

Catalog#	Length	Width
R0924A	7" (178mm)	¼" (6mm)
R0925A	7" (178mm)	⅜" (10mm)
R0926A	7" (178mm)	½" (13mm)
R0927A	7" (178mm)	⅝" (16mm)
R0928A	7" (178mm)	¾" (19mm)
R0929A	7" (178mm)	⅞" (22mm)
R0930A	7" (178mm)	1" (25mm)



R0924A



R0927A



R0930A





T. Fukushima Spatula

Copper, Ebenol-C Coated

Catalog#	Description	Length	Tip
R8959	Small	9" (229mm)	2mm
R8960	Medium	9" (229mm)	4mm
R8961	Large	9" (229mm)	6mm
R8998	X-Large	9" (229mm)	7mm



T. Fukushima Dura Spatula

Rigid, Stainless Steel

Catalog#	Description	Length	Tip
R8962	Curved, 60°	8" (203mm)	
R8963	Small	8" (203mm)	2mm
R8964	Medium	8" (203mm)	4mm
R8999	Large	8" (203mm)	6mm
R8979	X-Large	8" (203mm)	7mm



Scoville Nerve Root Retractor

Catalog#	Style	Length	Blade Width
RI000	Straight	9¼" (235mm)	7.5mm
RI005	Angular	9¼" (235mm)	7.5mm



RI000



RI005

D'Errico Nerve Root Retractor

Catalog#	Length	Blade Width
RN2102	8¾" (222mm)	¼" (6mm)



RN2102

Martin Nerve Root Retractor

Catalog#	Length	Blade Width
RI007	8½" (216mm)	7mm



RI007



Love Bayonet Nerve Root Retractor

Catalog#	Length	Blade Width
RI024	8¼" (210mm)	4mm



RI024

Love Nerve Root Retractor

Catalog#	Angle	Length	Blade Width
RI025	90°	7¾" (197mm)	7mm
RI026	45°	7¾" (197mm)	7mm
RI027	Straight	7¾" (197mm)	7mm



RI025



RI026



RI027

Holscher Nerve Root Retractor

Catalog#	Length	Blade Width
RN2104	9¾" (248mm)	¼" (6mm)
RN2105	9¾" (248mm)	½" (13mm)



RN2104

Nerve Root Retractor

Catalog#	Length	Blade Width
R6322	9½" (241mm)	6mm
R6323	9½" (241mm)	8mm
R6324	9½" (241mm)	10mm

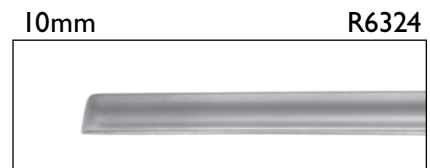
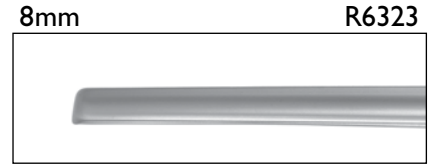
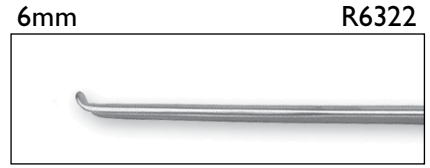

Suction Nerve Retractor

Catalog#	Length	Diameter	Blade Width
RN2211	8" (203mm)	7FR	6mm
RN2212	8" (203mm)	7FR	7mm
RN2213	8" (203mm)	7FR	8mm

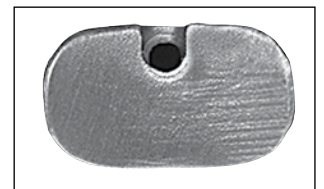
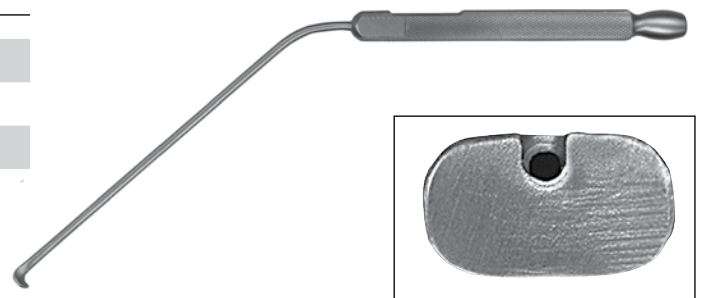

RN2213

RN2210 Suction Nerve Retractor Set (3)
Includes one each of items above



Senn Retractor

Double Ended

Catalog#	Description	Length	3 Prong Blade Width	Solid Blade
RI297	Sharp	6¼" (159mm)	9mm	20 × 6.5mm
RI298	Blunt	6¼" (159mm)	9mm	20 × 6.5mm



RI298

Volkman Retractor

Catalog#	Description	Length	Blade Width
RI233	2 Prong, Sharp	8¾" (222mm)	11mm
RI234	3 Prong, Sharp	8¾" (222mm)	18mm
RI235	4 Prong, Sharp	8¾" (222mm)	26mm
RI236	6 Prong, Sharp	8¾" (222mm)	40mm
RI237	2 Prong, Blunt	8¾" (222mm)	11mm
RI238	3 Prong, Blunt	8¾" (222mm)	18mm
RI239	4 Prong, Blunt	8¾" (222mm)	26mm
RI240	6 Prong, Blunt	8¾" (222mm)	40mm



RI235

Cushing Vein Retractor

Catalog#	Length	Blade Width
RI095	9" (229mm)	11.5mm



RI095

Cushing Decompression Retractor

Catalog#	Description	Length	Blade Width
RI100	Fenestrated	8¾" (222mm)	12mm



RI100

Meyering Retractor

Catalog#	Type	Length	Width
RN2300	Small	8" (203mm)	2" × 5/8" (51 × 16mm)
RN2301	Medium	9" (229mm)	3" × 1" (76 × 25mm)
RN2302	Large	9" (229mm)	3½" × 2" (89 × 51mm)



R1090

US Army Retractor Double Ended, Set of 2

Catalog#	Length	Blade	Blade
R1093	8½" (216mm)	29 × 15mm	45 × 15mm



R1093

Hibbs Retractor

Catalog#	Length	Blade Width
R1096	9½" (240mm)	3" × 1" (76 × 25mm)



R1096

Sachs Vein Retractors

Catalog#	Description	Length	Blade Width
RB2218	Angled, Sharp	8½" (216mm)	
RB2219	Angled, Plain	8½" (216mm)	12mm
RB2220	Angled, Tooth	8½" (216mm)	12mm



Taylor Spinal Retractor

Catalog#	Length	Blade
RN2320	7¼" (184mm)	3" × 1¼" (76 × 32mm)
RN2321	7¼" (184mm)	4" × 1¼" (102 × 32mm)
RN2322	7¼" (184mm)	3" × ¾" (76 × 19mm)
RN2323	7¼" (184mm)	4" × ¾" (102 × 19mm)



RN2320

Cloward Blade Retractor

Catalog#	Length	Width
RI060	7" (178mm)	18mm
RI061	7" (178mm)	20mm
RI062	7" (178mm)	23mm



RI062

Cloward Type (Old Style) Blade Retractor

Catalog#	Blade Length	Blade Width
RB2304	3" (76mm)	18mm
RB2305	3" (76mm)	20mm
RB2306	3" (76mm)	23mm



RB2305



Cervical Vertebral Spreader

Catalog#	Length	Tip Width
RI054	6" (152mm)	4mm



RI054

Improved Cervical Lamina Spreader

Catalog#	Length	Tip Width
RI050	6¼" (159mm)	4.5mm



RI050

Cloward Lamina Spreader

Catalog#	Length	Tip Width
RN2673	5¼" (133mm)	3mm



RN2673

Cloward Type Cervical Vertebral Spreader (picture not shown)

Catalog#	Description	Length
RB2308	With Teeth	6" (152mm)

Inge Lamina Spreader

Catalog#	Description	Length	Blade Width
RI075	Small	6½" (165mm)	7mm
RI070	Large	10½" (267mm)	11mm

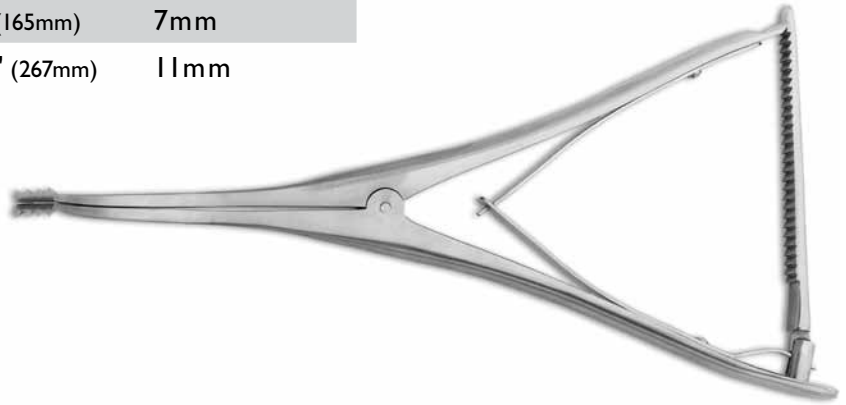

RI070

Lamina Spreader 2" (51mm) Jaw Opening

Catalog#	Description	Length	Blade Width
RN2688	Flat Blades	10½" (267mm)	15mm
RN2689	Concave Blades	11" (279mm)	16mm

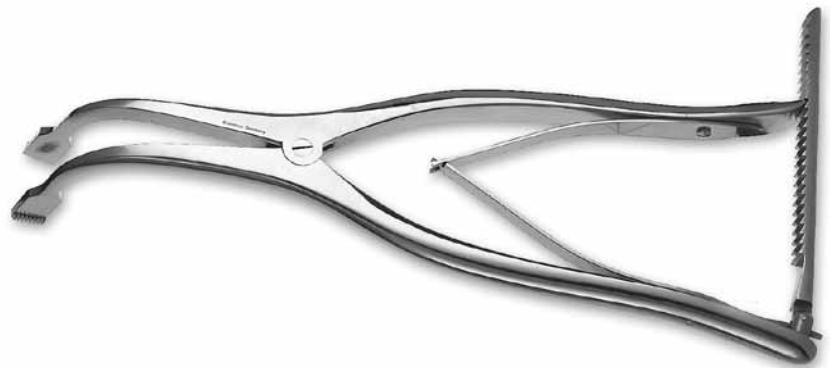

RN2688



Jansen Scalp Retractor

Catalog#	Description	Length	Blades
RI150	Blunt	4" (102mm)	20 × 13mm
RI151	Sharp	4" (102mm)	20 × 13mm



RI150

Jansen Deep Blade Scalp Retractor

Catalog#	Length	Blades
RI160	4 ⁵ / ₈ " (118mm)	17 × 22mm



RI160

Davis Scalp Retractor

Bayonet

Catalog#	Length
RI155	4 ⁵ / ₈ " (118mm)



RI155

Contour Scalp Retractor

3 × 4 Prongs, Blunt

Catalog#	Length	Blades
RN2015	5 ¹ / ₄ " (133mm)	19 × 17mm



RN2015

Snitman Retractor

3 × 3, Sharp Prongs

Catalog#	Length
RB2549	4 ¹ / ₂ " (114mm)



RB2549

Janetta Retractor Set

Catalog# Description

RN2400 Complete Set Includes: one Janetta Body, RN2401
two (2) Double Round Bars, RN2402
two (2) Single Round Bars, RN2403
one each Malleable Blades, RN2404-RN2409

Janetta Retractor Body

Catalog# Blade Width

RN2401 18mm



RN2401

Janetta Double Round Bar

Catalog# Description

RN2402 Double

RN2403 Single



RN2402



RN2403

Janetta Malleable Blades

Catalog# Blade

RN2404 70 × 15mm

RN2405 70 × 20mm

RN2406 70 × 25mm

RN2409 95 × 5mm

RN2407 95 × 10mm

RN2408 95 × 20mm



RN2404



RN2405



RN2406



RN2409



RN2407



RN2408



Gelpi Retractor

Catalog#	Length
RN2501	7¾" (197mm)
RN2502	5⅛" (130mm)
RN2503	4⅝" (117mm)
RN2504	3⅝" (92mm)



RN2502

Seltz-Gelpi Retractor

Sharp Tips, Bent Arms

Catalog#	Length
RN2506	6½" (165mm)



RN2506

Markham-Meyerding Retractor

Catalog#	Blade	Length	Blade Width
RI272	Right	6½" (165mm)	25 × 50mm
RI273	Left	6½" (165mm)	25 × 50mm



RI272

Meyerding Retractor

Catalog#	Length	Blades
RI275	7¾" (197mm)	60 × 25mm
RI280	7¾" (197mm)	54 × 25mm
RI285	7¾" (197mm)	31 × 25mm
RI290	7¾" (197mm)	63 × 19mm

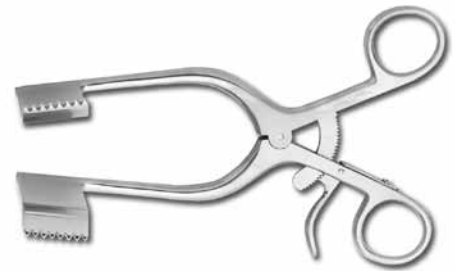

RI275

Wiltse-Gelpi Retractor

Catalog#	Length
RB2286	10¾" (273mm)

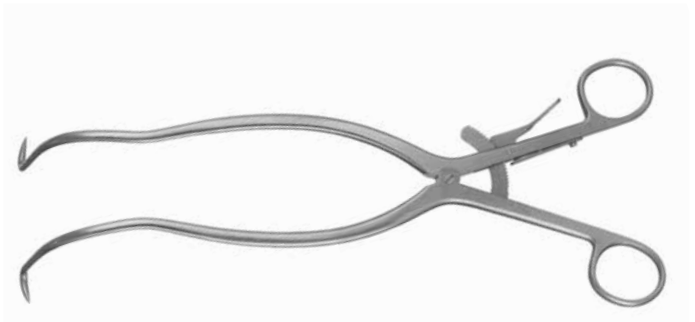

RB2286

Ducker Retractor

Catalog#	Blade	Length	Width
RN2721	Left	6¾" (171mm)	50 × 20mm
RN2722	Right	6¾" (171mm)	50 × 20mm
RN2723	Left	6¾" (171mm)	70 × 20mm
RN2724	Right	6¾" (171mm)	70 × 20mm



RN2721

RN2720 Ducker Retractor Set (4)
Includes one each of items above

Double Ducker Retractor

Catalog#	Length	Blade
RN27225	7½" (191mm)	60 × 20mm
RN27235	7½" (191mm)	73 × 20mm



RN27235

Deeper Ducker Retractor

Catalog#	Length	Blade
RN27245	7½" (191mm)	90 × 21mm

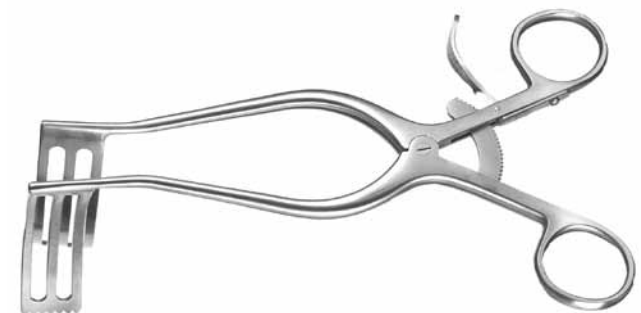

RN27245



Williams Style Discectomy Retractor

Catalog#	Style	Blade	Length	Blade
R7250	Narrow	Left	6¾" (171mm)	50 × 10mm
R7251	Narrow	Right	6¾" (171mm)	50 × 10mm
R7252	Narrow	Left	6¾" (171mm)	60 × 10mm
R7253	Narrow	Right	6¾" (171mm)	60 × 10mm
R7254	Narrow	Left	6¾" (171mm)	70 × 10mm
R7255	Narrow	Right	6¾" (171mm)	70 × 10mm
R7260	Wide	Left	6¾" (171mm)	50 × 20mm
R7261	Wide	Right	6¾" (171mm)	50 × 20mm
R7262	Wide	Left	6¾" (171mm)	60 × 20mm
R7263	Wide	Right	6¾" (171mm)	60 × 20mm
R7264	Wide	Left	6¾" (171mm)	70 × 20mm
R7265	Wide	Right	6¾" (171mm)	70 × 20mm



R7250

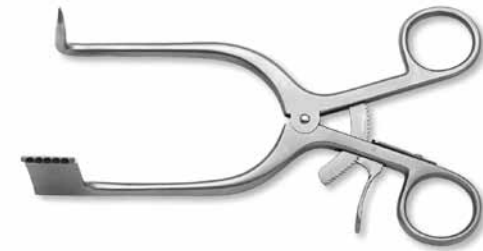

R7261

Feler-Ducker Retractor

Catalog#	Blade	Length	Blade
RN2726	Left	6¾" (171mm)	50 × 10mm
RN2727	Right	6¾" (171mm)	50 × 10mm
RN2728	Left	6¾" (171mm)	70 × 10mm
RN2729	Right	6¾" (171mm)	70 × 10mm



RN2729

RN2725 Feler-Ducker Retractor Set of (4)

Includes one each of items above

Weitlaner Self-Retaining Retractor

2 × 3 Prongs

Catalog#	Description	Length	Blades
RI220	Sharp	4 3/8" (111mm)	15.5 × 12mm
RI221	Blunt	4 3/8" (111mm)	15.5 × 12mm

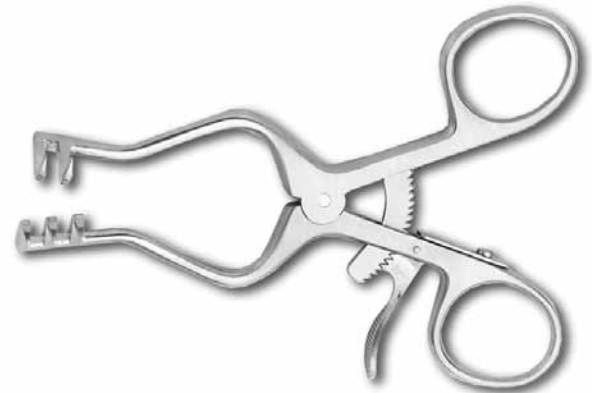

RI220

Weitlaner Self-Retaining Retractor

3 × 4 Prongs

Catalog#	Description	Length	Blades
RI200	Sharp	5 3/8" (137mm)	17 × 19mm
RI201	Blunt	5 3/8" (137mm)	17 × 19mm
RI205	Sharp	6 1/2" (165mm)	18 × 19mm
RI206	Blunt	6 1/2" (165mm)	18 × 19mm
RI210	Sharp	7 3/4" (197mm)	21 × 19mm
RI211	Blunt	7 3/4" (197mm)	21 × 19mm
RI215	Sharp	9 1/2" (241mm)	27 × 21mm
RI216	Blunt	9 1/2" (241mm)	27 × 21mm



RI200

Hoehn Retractor

Body with Two (2) Sets of Blades

Catalog#	Length	Blade 1	Blade 2
RN2536	10" (254mm)	75 × 24mm	53 × 45 mm



RN2536



Weitlaner Hinged Self-Retaining Retractor

3 × 4 Prongs

Catalog#	Description	Length	Blades
RI225	Sharp	5½" (140mm)	18 × 18mm
RI226	Blunt	5½" (140mm)	18 × 18mm
RI230	Sharp	6½" (165mm)	18 × 18mm
RI231	Blunt	6½" (165mm)	18 × 18mm
RN2614	Sharp	8" (203mm)	18 × 18mm



RI225

Weitlaner Angled Self-Retaining Retractor

3 × 4 Prongs

Catalog#	Description	Length	Blades
RI208	Sharp	6½" (165mm)	19 × 19mm
RI209	Blunt	6½" (165mm)	19 × 19mm
RI217	Sharp	9½" (241mm)	19 × 19mm
RI218	Blunt	9½" (241mm)	19 × 19mm



RI208

Miskimon Cerebellum Retractor

7 × 7 Prongs, Angled

Catalog#	Description	Length
RN2540	Sharp	7¾" (197mm)



RN2540

Adson Cerebella Retractor

Catalog#	Description	Length	Blades
R1189	Blunt	7½" (191mm)	23 × 18mm
R1190	Sharp	7½" (191mm)	23 × 18mm

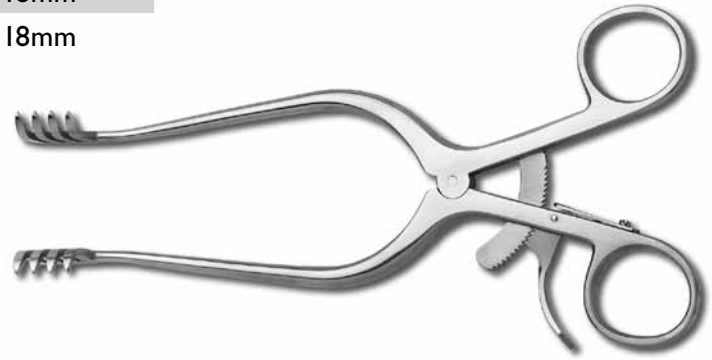

R1190

Adson Cerebella Retractor

Angled Arms

Catalog#	Description	Length	Blades
R1194	Blunt	7¼" (184mm)	23 × 18mm
R1195	Sharp	7¼" (184mm)	23 × 18mm



R1194

Anderson-Adson Cerebella Retractor

Catalog#	Length
R1197	7¾" (197mm)

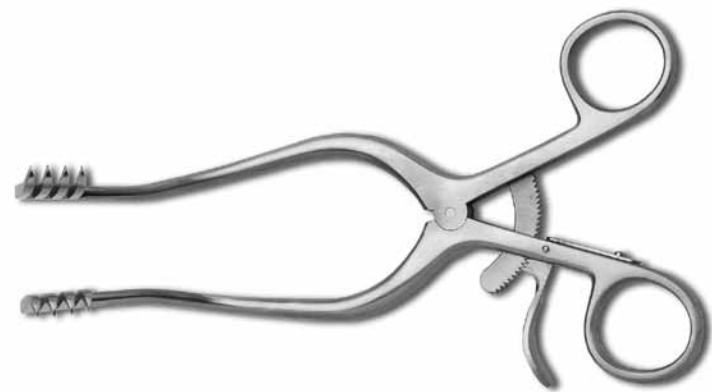

R1197



Beckman-Adson Retractor

Hinged Arms, 4 × 4 Prongs

Catalog#	Description	Length	Blades
R1165	Blunt	12" (305mm)	30 × 28mm
R1166	Sharp	12" (305mm)	30 × 28mm
R1170	Wide, Sharp	12" (305mm)	48 × 28mm
RB2252	Wide, Blunt	12" (305mm)	48 × 28mm

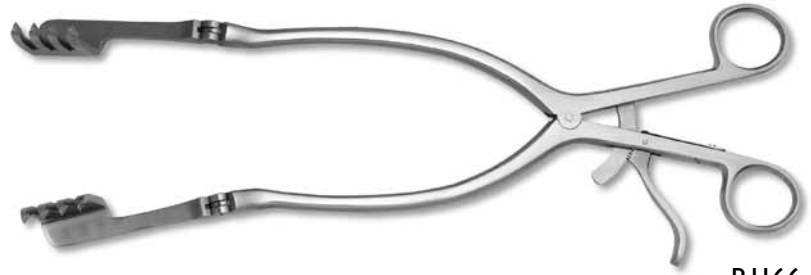

R1166

Beckman-Eaton Retractor

Hinged Arms, 7 × 7 Prongs

Catalog#	Description	Length	Blades
R1175	Wide, Sharp	12 ³ / ₄ " (324mm)	49 × 43mm

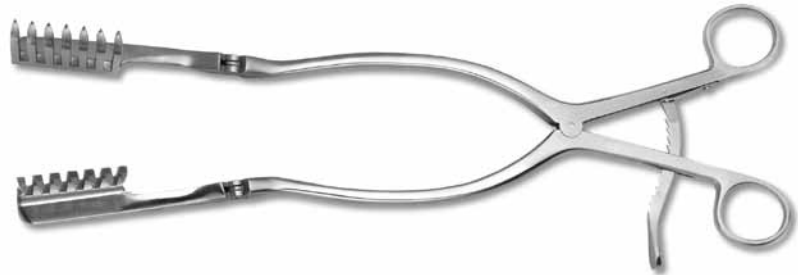

R1175

Oberhill Retractor

4 Prong

Catalog#	Length	Blades
RN2528	12" (305mm)	1/2" × 1" (38 × 25mm)



RN2528

Scoville Type Hemilaminectomy Retractor Body

Catalog#	Spread
R1106	8½" (216mm)



R1106

Scoville Haverfield Type Hemilaminectomy Retractor Body

Catalog#	Spread
R1111	8½" (216mm)



R1111

Scoville Type Hemilaminectomy Hook Blades with Cross Bar

Catalog#	Length
R1113	2¾" (60mm)
R1114	3⅛" (79mm)



R1113

Scoville Type Hemilaminectomy Hook Blades

Catalog#	Length
R1115	2¾" (60mm)
R1116	3⅛" (79mm)



R1115



Scoville Type Hemilaminectomy Blades

with Teeth

Catalog#	Width	Length
R1118	1" (25mm)	2½" (64mm)
R1119	2" (51mm)	2½" (64mm)
R1120	1¼" (32mm)	2⅝" (67mm)
R1121	1" (25mm)	3½" (89mm)



R1118

Scoville Type Hemilaminectomy Blades

with Prongs

Catalog#	Width	Length
R1123	1½" (38mm)	1⅝" (41mm)
R1124	1⅞" (48mm)	2⅝" (67mm)



R1123

Meyerding Type Hemilaminectomy Blades

Catalog#	Width	Length
R1126	1" (25mm)	2⅜" (60mm)
R1127	1" (25mm)	3" (76mm)
R1128	2" (51mm)	3¼" (83mm)



R1127

Taylor Type Hemilaminectomy Blades Single Tooth

Catalog#	Width	Length
R1130	1 ¼" (31mm)	3" (76mm)
R1131	1 ¼" (31mm)	4" (102mm)

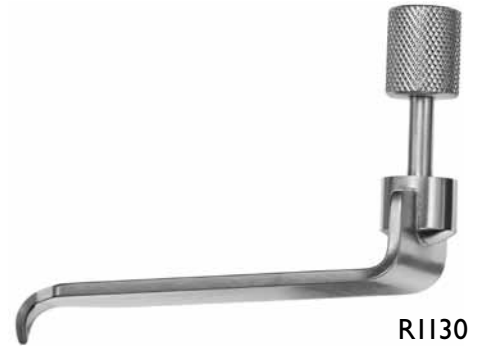

Hibbs Type Hemilaminectomy Blades with Prongs

Catalog#	Width	Length
R1134	1" (25mm)	2" (51mm)
R1135	2" (51mm)	2" (51mm)
R1136	1" (25mm)	2 ½" (64mm)
R1137	1 ½" (38mm)	2 ½" (64mm)
R1138	1" (25mm)	3" (75mm)
R1139	1 ½" (38mm)	3" (75mm)
R1140	2" (51mm)	3" (75mm)
R1142	1" (25mm)	3 ½" (89mm)
R1143	1 ½" (38mm)	3 ½" (89mm)
R1144	1" (25mm)	4" (102mm)
R1145	2" (51mm)	4" (102mm)



Taylor Type Hemilaminectomy Blades with Prongs

Catalog#	Description	Width	Length
R1146	3 Prong, Small	1 ½" (38mm)	1 ¾" (45mm)
R1147	4 Prong, Small	2" (51mm)	1 7/8" (48mm)
R1148	4 Prong, Small	2 ½" (64mm)	2 ½" (64mm)
R1149	4 Prong, Small	2 ¼" (57mm)	3 1/8" (79mm)





Gardner-Wells Traction Tongs Set

Maximum opening of 8"

Catalog#	Description	Maximum Opening
R1945	Set Includes: one Test Bar two (2) Fixation Screws one "S" Hook two (2) Lock Nuts	6 1/4" (159mm)



R1945

Gardner-Wells Traction Tongs Set

Components

Catalog#	Description	Length
R1942	Lock Nuts	
R1946	Test Bar	4 3/4" (121mm)
R1947	Fixation Screw	
R1949	"S" Hook	



R1947

Titanium Gardner-Wells Traction Tongs

Catalog#	Description	Maximum Opening
R1944	Maximum Opening	6 1/4" (159mm)
R1944TS	Spare Screw (pair)	



R1944



RONGEURS



DeVilbiss Cranial Rongeur

Catalog#	Length
RI300	8½" (216mm)



RI300

Stille-Liston Bone Cutting Rongeur

Catalog#	Description	Length	Jaw Length
RI305	Straight	10½" (267mm)	33 mm
RI306	Curved	10½" (267mm)	27mm



RI305

Stille-Horsley Bone Cutting Rongeur

Catalog#	Description	Length	Jaw Length
RI307	Double Curved	9¾" (248mm)	26 mm



RI307

Ruskin-Liston Bone Cutting Rongeur

Catalog#	Description	Length	Jaw Length
RI310	Straight	7¼" (184mm)	22 mm
RI312	Up Angled	7¼" (184mm)	22 mm



RI310

Ruskin-Rowland Bone Cutting Forceps

Catalog#	Description	Length	Jaw Length
RB2054	Straight	7¼" (184mm)	19mm
RB2055	Angled	7¼" (184mm)	19mm



RB2054

Liston Bone Cutting Forceps

Catalog#	Description	Length	Jaw Length
RB2064	Straight	5¾" (146mm)	24mm
RB2065	Straight	6½" (165mm)	26mm
RB2066	Straight	7½" (191mm)	39mm
RB2067	Straight	8¾" (222mm)	40mm
RB2068	Angled	5¾" (146mm)	23mm
RB2069	Angled	6½" (165mm)	26mm
RB2070	Angled	7½" (191mm)	40mm
RB2071	Angled	8¾" (222mm)	40mm

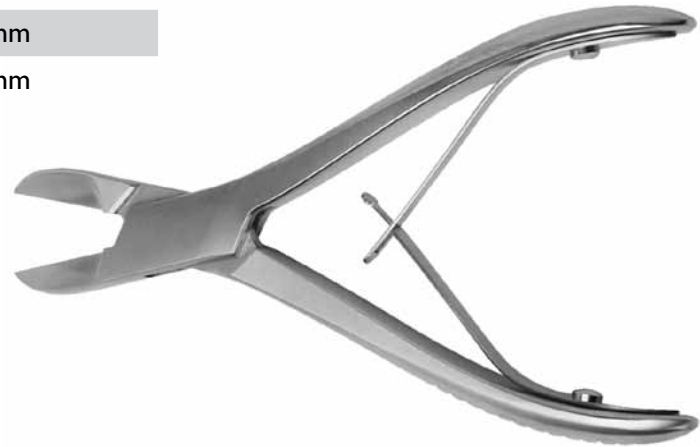

RB2066

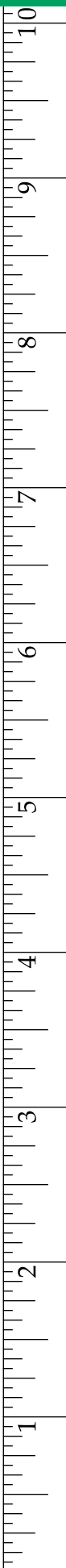



Stookey Single Action Bone Rongeur

Catalog#	Bite Size	Length	Jaw
R1320	3mm	7½" (191mm)	2.5 × 13mm



R1320

Lempert Single Action Bone Rongeur

Catalog#	Description	Bite Size	Length	Jaw
R1324	Straight	2mm	6¼" (159mm)	2.5 × 11mm
R1325	Curved	2mm	6¼" (159mm)	2.5 × 11mm
R1326	Straight	2mm	7½" (191mm)	2.5 × 11mm
R1327	Curved	2mm	7½" (191mm)	2.5 × 11mm

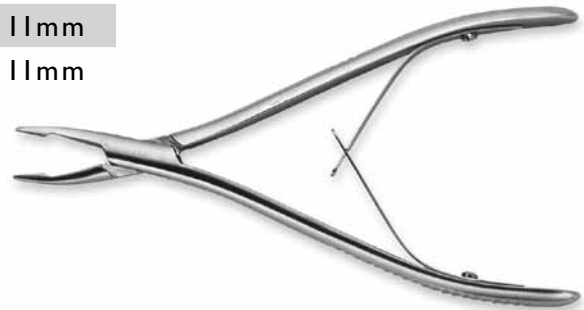

R1325

Adson Single Action Bone Rongeur

Catalog#	Bite Size	Length	Jaw
R1330	8mm	8¼" (210mm)	8 × 17mm



R1330

Bacon Rongeur

Catalog#	Description	Length	Jaw
RB2002	Angled	7" (178mm)	6 × 12mm



RB202

Stille Double Action Bone Rongeur

Catalog#	Description	Length	Jaw
RI470	Straight	8 ³ / ₄ " (222mm)	9 × 16mm
RI475	Curved	8 ³ / ₄ " (222mm)	9 × 16mm
RI480	Angular	9" (229mm)	8 × 15mm



RI470



RI475



RI480

Stille-Echlin Double Action Bone Rongeur Flat Lower Jaw

Catalog#	Bite Size	Length	Jaw
RI385	6mm	9" (229mm)	6 × 14mm



RI385

Beyer Rongeur

Catalog#	Description	Length	Jaw
RB2003	Curved	7" (178mm)	3 × 18mm
RB2044	Curved	7" (178mm)	4 × 18mm



RB2003

Stille-Luer Double Action Bone Rongeur

Catalog#	Description	Length	Jaw
RN3022	Straight	8¾" (222mm)	10 × 16 mm
RN3023	Curved	8¾" (222mm)	10 × 16 mm
RN3024	Straight	10" (254mm)	10 × 16 mm
RN3025	Curved	10" (254mm)	10 × 16 mm



RN3024

Stille-Luer Duckbill Double Action Bone Rongeur

Catalog#	Bite Size	Length	Jaw
RN3026	5mm	9" (229mm)	6 × 13 mm



RN3026

Smith-Peterson Double Action Bone Rongeur

Catalog#	Description	Length	Jaw
R1381	Straight	9½" (241mm)	3.5 mm
R1382	Slight Curve	9½" (241mm)	3.5 mm
R1383	Full Curve	9½" (241mm)	3.5 mm
R1386	Straight	8" (203mm)	3 mm
R1387	Slight Curve	8" (203mm)	3 mm
R1388	Full Curve	7½" (191mm)	3 mm



R1381

Ruskin Double Action Bone Rongeur

Catalog#	Description	Length	Jaw
R1338	Straight	6" (152mm)	2 × 17mm
R1339	Curved	6" (152mm)	2 × 17mm
R1340	Straight	7¼" (184mm)	5 × 15mm
R1341	Curved	7¼" (184mm)	5 × 15mm
R1342	Straight	7¼" (184mm)	6 × 15mm
R1343	Curved	7¼" (184mm)	6 × 15mm
R1344	Duckbill	7¼" (184mm)	6 × 14mm



R1338

Ruskin Rongeur

Catalog#	Description	Length	Jaw
RB2014	Strong Curved	6" (152mm)	3 × 9mm
RB2015	Curved	6" (152mm)	4 × 17mm



RB2014

Double Action Rongeur

Catalog#	Length	Jaw
RB2047	14½" (368mm)	8 × 18mm



RB2047



Zaufal-Jansen Double Action Bone Rongeur

Catalog#	Description	Length	Jaw
R1350	Curved	7" (178mm)	4mm



R1350

Beyer Double Action Bone Rongeur

Catalog#	Length	Jaw
R1355	7" (178mm)	3 × 18mm



R1355

Echlin Double Action Bone Rongeur

Catalog#	Length	Jaw
R1370	9" (229mm)	2 × 14mm
R1375	9" (229mm)	3 × 14mm
R1380	9" (229mm)	4 × 14mm



R1370

Fulton Double Action Bone Rongeur

Catalog#	Description	Length	Jaw
R1390	Straight	9½" (241mm)	7mm
R1391	Slight Curve	9½" (241mm)	7mm
R1392	Full Curve	9½" (241mm)	7mm



R1390

Leksell Double-Action Bone Rongeur

Catalog#	Description	Length	Jaw
RN3032	Regular Curve	9¼" (235mm)	3 × 16mm
RN3031	Regular Curve	9¼" (235mm)	5 × 16mm
RN3030	Regular Curve	9¼" (235mm)	8 × 16mm
RN3035	Strong Curve	9¼" (235mm)	3 × 14mm
RN3034	Strong Curve	9¼" (235mm)	5 × 14mm
RN3033	Strong Curve	9¼" (235mm)	8 × 14mm



RN3030



RN3035

Hercules Triple Action Wire Cutter

30° Blades (Cuts 3.0mm wire)

The Hercules Triple Action Wire Cutter will enable cutting of up to 3mm pins with ease. The jaws feature a unique gripping action which eliminated free-fragment release.

Super Master Wire Cutter

Catalog#	Description	Length
R3325	30° Angle Blades, 23cm Cuts 3.0mm Hard Wire	8½" (216mm)



R3325

Catalog#	Description
R3320	Tungsten Carbide Inserts for R3325

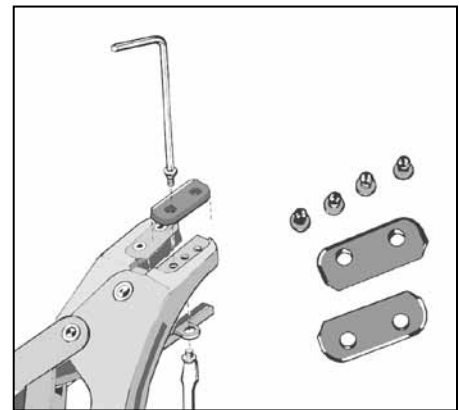

R3320

Catalog#	Description
R3321	Pin Holding Inserts for R3325

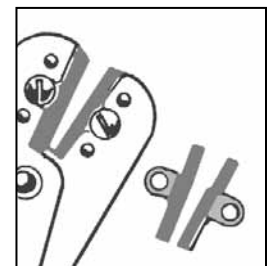

R3321



Cushing Delicate Pattern Intervertebral Disc Rongeur

2 × 10mm Bite

Catalog#	Description	Length
RN5712	Straight	7" (178mm)
RN5712X	Straight w/ Teeth	7" (178mm)
RN5722	Up	7" (178mm)
RN5722X	Up w/ Teeth	7" (178mm)
RN5732	Down	7" (178mm)



RN5712

Cushing Intervertebral Disc Rongeur

1.5 × 10mm Bite

Description	6" (152mm)	7" (178mm)	9" (229mm)
Straight	RN5680	RN5780	RN5980
Up	RN5681	RN5781	RN5981
Down	RN5682	RN5782	RN5982



RN5780

Cushing Intervertebral Disc Rongeur

2 × 10mm Bite

Description	5" (127mm)	6" (152mm)	7" (178mm)	9" (229mm)	10" (254mm)	11" (280mm)	12" (305mm)
Straight	RN5512H	RN5612H	RN5712H	RN5912H	RB6246	RN51112H	RN51212H
Up	RN5522H	RN5622H	RN5722H	RN5922H	RB6247	RN51122H	RN51222H
Down	RN5532H	RN5632H	RN5732H	RN5932H	RB6248	RN51132H	RN51232H
Straight w/Teeth			RR5712X				
Up w/Teeth		RN5622X	RR5722X				
Down w/Teeth			RN5732X				



RN5612H

Love-Gruenwald Delicate Pattern Intervertebral Disc Rongeur
3 × 10mm Bite

Catalog#	Description	Length
RN5743	Straight	7" (178mm)
RN5743X	Straight w/Teeth	7" (178mm)
RN5753	Up	7" (178mm)
RN5753X	Up w/Teeth	7" (178mm)
RN5763	Down	7" (178mm)
RN5763X	Down w/Teeth	7" (178mm)



RN5763

Love-Gruenwald Intervertebral Disc Rongeur
3 × 10mm Bite

Description	5" (127mm)	6" (152mm)	7" (178mm)	9" (229mm)	10" (254mm)	11" (280mm)	12" (305mm)
Straight	RN5543H	RN5643H	RN5743H	RN5943H	RB6249	RN51143H	RN51243H
Up	RN5553H	RN5653H	RN5753H	RN5953H	RB6250	RN51153H	RN51253H
Down	RN5563H	RN5663H	RN5763H	RN5963H	RB6251	RN51163H	RN51263H
Straight w/Teeth			RN5743HX				
Up w/Teeth			RN5753HX				
Down w/Teeth			RN5763HX				



RN5943H



Poppen Intervertebral Disc Rongeur
4 × 7mm Bite

Catalog#	Description	Length
R1785	Straight	5" (127mm)
R1786	Up	5" (127mm)
R1787	Down	5" (127mm)
R1765	Straight	7" (178mm)
R1766	Up	7" (178mm)
R1767	Down	7" (178mm)



R1785

Intervertebral Disc Rongeur
5 × 10mm Bite

Catalog#	Description	Length
R18045	Straight	9" (229mm)
R18055	Up	9" (229mm)
R18065	Down	9" (229mm)
R18165	Straight	11" (280mm)
R18175	Up	11" (280mm)
R18185	Down	11" (280mm)
R18615	Straight	12" (305mm)
R18625	Up	12" (305mm)
R18635	Down	12" (305mm)



R18185

Spurling Delicate Pattern Intervertebral Disc Rongeur 4 × 10mm Bite

Catalog#	Description	Length
RN5744	Straight	7" (178mm)
RN5744X	Straight w/Teeth	7" (178mm)
RN5754	Up	7" (178mm)
RN5754X	Up w/Teeth	7" (178mm)
RN5764	Down	7" (178mm)
RN5764X	Down w/Teeth	7" (178mm)



RN5744



RN5754



RN5764

Spurling Intervertebral Disc Rongeur 4 × 10mm Bite



RN5744H

Description	5" (127mm)	6" (152mm)	7" (178mm)	9" (229mm)	10" (254mm)	11" (280mm)	12" (305mm)
Straight	RN5544H	RN5644H	RN5744H	RN5944H	RB6252	RN51144H	RN51244H
Up	RN5554H	RN5654H	RN5754H	RN5954H	RB6253	RN51154H	RN51254H
Down	RN5564H	RN5664H	RN5764H	RN5964H	RB6254	RN51164H	RN51264H
Straight w/Teeth			RB6307				
Up w/Teeth			RB6308				
Down w/Teeth			RB6309				



Spurling Intervertebral Disc Rongeur
 3 × 10mm Bite

Catalog#	Description	Length
R1758	Angled Tip Left	7" (178mm)
R1759	Angled Tip Right	7" (178mm)



R1758

Cloward Intervertebral Disc Rongeur
 Fenestrated with Teeth, 6 × 10mm Bite

Catalog#	Description	Length
R1790	Straight	5½" (140mm)
R1791	Up	5½" (140mm)
R1792	Down	5½" (140mm)



R1790



Peapod Intervertebral Disc Rongeur

Catalog#	Description	Length	Bite
RB6126	Small	5½" (140mm)	2 × 7mm
RN5526	Small	5½" (140mm)	2.5 × 7mm
RN5527	Medium	5½" (140mm)	3 × 7mm
RN5528	Large	5½" (140mm)	4 × 7mm
RI722	Small	7" (178mm)	2.5 × 7mm
RI723	Medium	7" (178mm)	3 × 7mm
RI724	Large	7" (178mm)	4 × 7mm

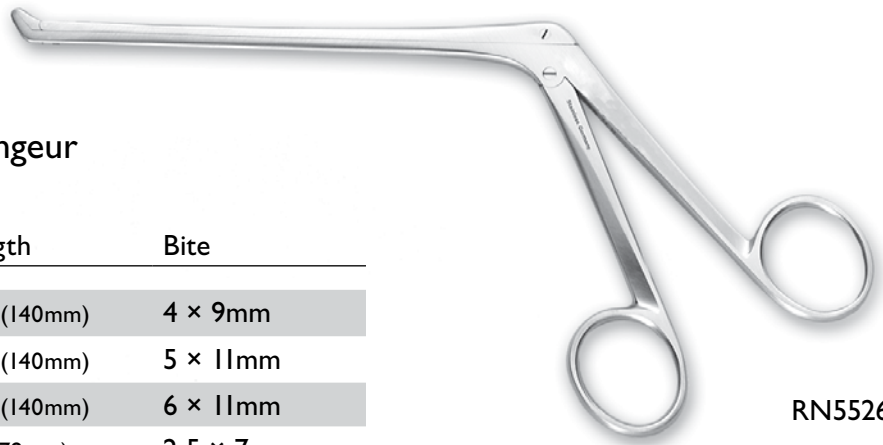

RN5526

Wilde Intervertebral Disc Rongeur Fenestrated, Delicate Pattern

Catalog#	Description	Length	Bite
RN5603	Straight	5½" (140mm)	4 × 9mm
RN5604	Straight	5½" (140mm)	5 × 11mm
RN5605	Straight	5½" (140mm)	6 × 11mm
RB6007	Straight	7" (178mm)	2.5 × 7mm
RN5703	Straight	7" (178mm)	3 × 8mm
RN5704	Straight	7" (178mm)	4 × 9mm
RN5705	Straight	7" (178mm)	5 × 11mm
RN5903	Straight	9" (229mm)	3 × 8mm
RN5904	Straight	9" (229mm)	4 × 9mm
RN5905	Straight	9" (229mm)	5 × 11mm
RB6011	Angled Up	7" (178mm)	2.5 × 7mm
RB6012	Angled Up	7" (178mm)	3 × 8mm
RB6013	Angled Up	7" (178mm)	4 × 9mm
RB6014	Angled Up	7" (178mm)	5 × 11mm

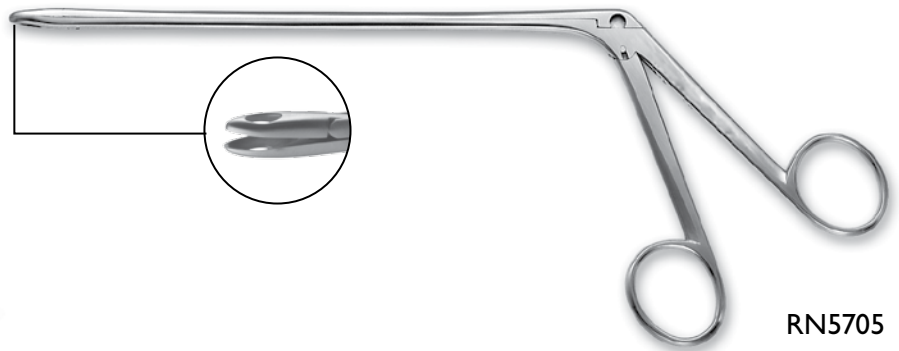

RN5705

Wilde Intervertebral Disc Rongeur
 Fenestrated

Catalog#	Description	Bite	Length
R1711	Straight	2.5 × 7mm	7" (178mm)
R1712	Straight	3 × 8mm	7" (178mm)
R1713	Straight	4 × 9mm	7" (178mm)
R1714	Straight	5 × 11mm	7" (178mm)
R1716	Angled Up	2.5 × 7mm	7" (178mm)
R1717	Angled Up	3 × 8mm	7" (178mm)
R1718	Angled Up	4 × 9mm	7" (178mm)
R1719	Angled Up	5 × 11mm	7" (178mm)
R1711L	Long Jaw, Straight	2.5 × 7mm	7" (178mm)
R1712L	Long Jaw, Straight	3 × 8mm	7" (178mm)
R1713L	Long Jaw, Straight	4 × 9mm	7" (178mm)
R1714L	Long Jaw, Straight	5 × 11mm	7" (178mm)
R1716L	Long Jaw, Angled Up	2.5 × 7mm	7" (178mm)
R1717L	Long Jaw, Angled Up	3 × 8mm	7" (178mm)
R1718L	Long Jaw, Angled Up	4 × 9mm	7" (178mm)
R1719L	Long Jaw, Angled Up	5 × 11mm	7" (178mm)

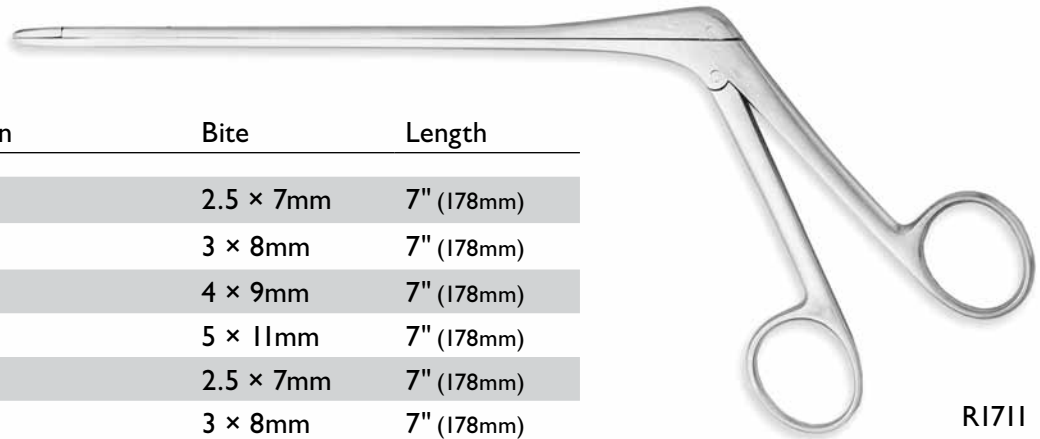

R1711



R1716



Caspar Intervertebral Disc Rongeur

Double Fenestrated with Teeth

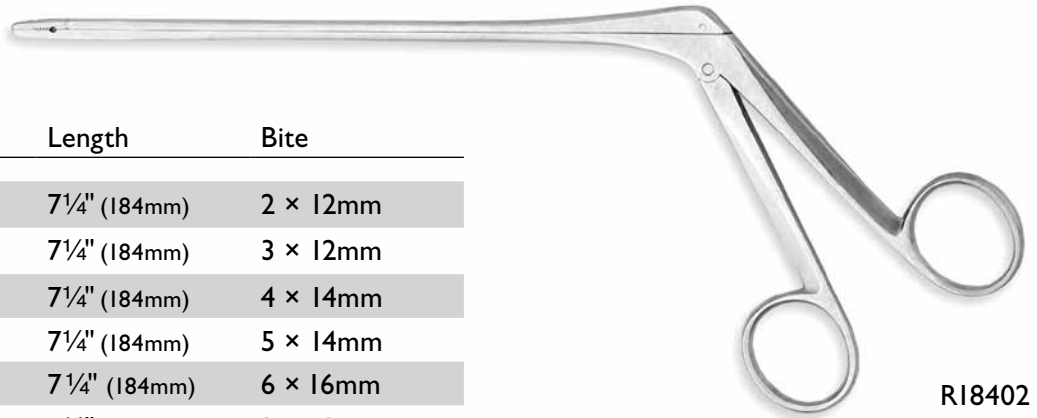

R18402



R18453



R18503

Catalog#	Description	Length	Bite
R18402	Straight	7 1/4" (184mm)	2 × 12mm
R18403	Straight	7 1/4" (184mm)	3 × 12mm
R18404	Straight	7 1/4" (184mm)	4 × 14mm
R18405	Straight	7 1/4" (184mm)	5 × 14mm
RB6415	Straight	7 1/4" (184mm)	6 × 16mm
R18453	Up	7 1/4" (184mm)	3 × 12mm
R18454	Up	7 1/4" (184mm)	4 × 14mm
R18455	Up	7 1/4" (184mm)	5 × 14mm
R18503	Down	7 1/4" (184mm)	3 × 12mm
R18504	Down	7 1/4" (184mm)	4 × 12mm
RB6401	Straight	6 1/4" (159mm)	2 × 12mm
RB6402	Straight	6 1/4" (159mm)	3 × 12mm
RB6403	Straight	6 1/4" (159mm)	4 × 14mm
RB6404	Straight	6 1/4" (159mm)	5 × 14mm
RB6405	Straight	6 1/4" (159mm)	6 × 16mm
RB6406	Up	6 1/4" (159mm)	3 × 12mm
RB6407	Up	6 1/4" (159mm)	4 × 14mm
RB6408	Up	6 1/4" (159mm)	5 × 14mm
RB6409	Down	6 1/4" (159mm)	3 × 12mm
RB6410	Down	6 1/4" (159mm)	3 × 12mm

Jackson Intervertebral Disc Rongeur
 4 × 8mm Bite

Catalog#	Description	Length
R1745	70°Up	7" (178mm)



R1745

Micro Disc Rongeur
 1 × 2 teeth

Catalog#	Description	Length
RN7132	Straight	5½" (140mm)



RN7132

Williams Style Micro Disc IVD
 Delicate Pattern, 1 × 2 teeth

Catalog#	Description	Length
RB6154	Straight	7" (178mm)
RB6155	Straight	10" (254mm)



RB6154

Ferris-Smith Intervertebral Disc Rongeur

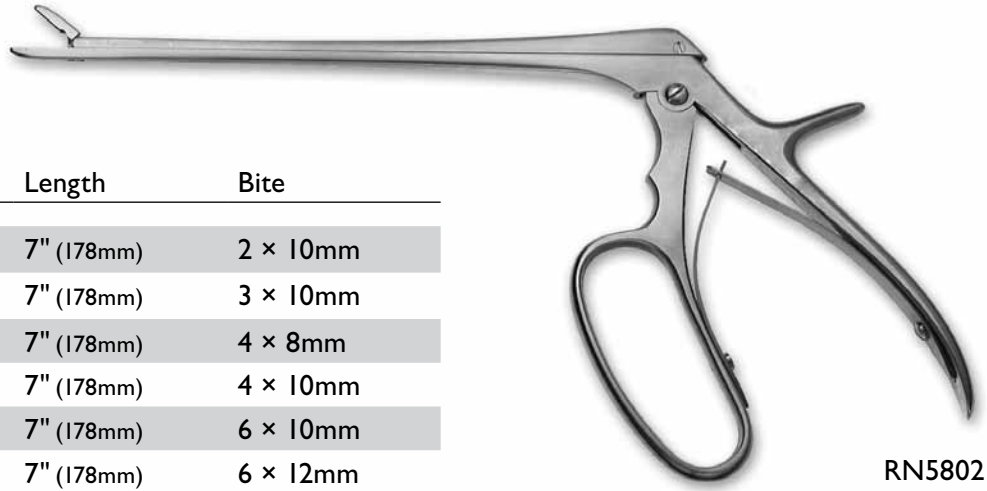

Catalog#	Description	Length	Bite
RN5802	Straight	7" (178mm)	2 × 10mm
RN5803	Straight	7" (178mm)	3 × 10mm
RN5808	Straight	7" (178mm)	4 × 8mm
RN5804	Straight	7" (178mm)	4 × 10mm
RN5806	Straight	7" (178mm)	6 × 10mm
RN5805	Straight	7" (178mm)	6 × 12mm
RN5812	Up	7" (178mm)	2 × 10mm
RN5813	Up	7" (178mm)	3 × 10mm
RN5814	Up	7" (178mm)	4 × 8mm
RN5816	Up	7" (178mm)	6 × 10mm
RN5822	Down	7" (178mm)	2 × 10mm
RN5823	Down	7" (178mm)	3 × 10mm
RN5824	Down	7" (178mm)	4 × 8mm
RN5826	Down	7" (178mm)	6 × 10mm

RN5802

Decker Intervertebral Disc Rongeur

2 × 6mm Bite



Catalog#	Description	Length
RN7127	Right	6" (152mm)
RN7128	Left	6" (152mm)
RN7129	Down	6" (152mm)
RN7130	Up	6" (152mm)
RN7131	Straight	6" (152mm)

RN7131



Ultra-Coat™ Bayonet Cushing IVD Rongeurs

Catalog#	Description	Working Length	Bite
RB6801	Straight	4 3/4" (121mm)	1.5 × 10mm
RB6802	Up	4 3/4" (121mm)	1.5 × 10mm
RB6803	Down	4 3/4" (121mm)	1.5 × 10mm
RB6804	Straight	4 3/4" (121mm)	2 × 10mm
RB6805	Up	4 3/4" (121mm)	2 × 10mm
RB6806	Down	4 3/4" (121mm)	2 × 10mm

Ultra-Coat™ Bayonet Love-Gruenwald IVD Rongeurs

Catalog#	Description	Working Length	Bite
RB6821	Straight	4 3/4" (121mm)	3 × 10mm
RB6822	Up	4 3/4" (121mm)	3 × 10mm
RB6823	Down	4 3/4" (121mm)	3 × 10mm

Ultra-Coat™ Bayonet Spurling IVD Rongeurs

Catalog#	Description	Working Length	Bite
RB6841	Straight	4 3/4" (121mm)	4 × 10mm
RB6842	Up	4 3/4" (121mm)	4 × 10mm
RB6843	Down	4 3/4" (121mm)	4 × 10mm

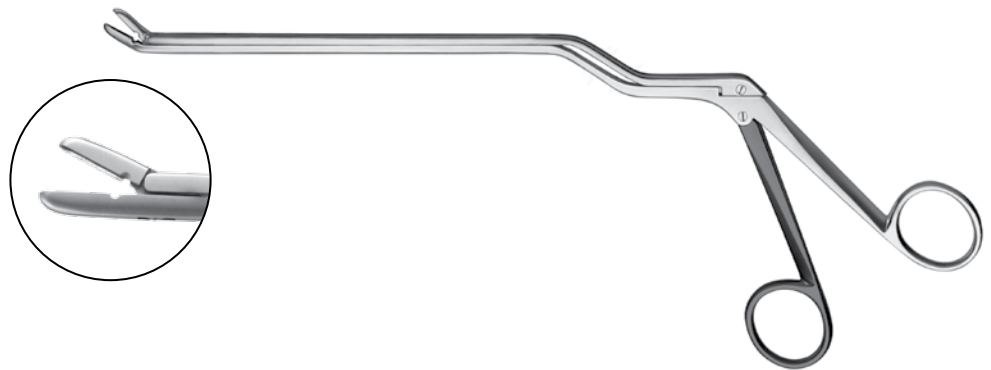

RB6822

Bayonet Cushing IVD Rongeurs

Catalog#	Description	Working Length	Bite
RB6601	Straight	4¾" (12.1cm)	1.5 × 10mm
RB6602	Up	4¾" (12.1cm)	1.5 × 10mm
RB6603	Down	4¾" (12.1cm)	1.5 × 10mm
RB6604	Straight	4¾" (12.1cm)	2 × 10mm
RB6605	Up	4¾" (12.1cm)	2 × 10mm
RB6606	Down	4¾" (12.1cm)	2 × 10mm

Bayonet Love-Gruenwald IVD Rongeurs

Catalog#	Description	Working Length	Bite
RB6621	Straight	4¾" (12.1cm)	3 × 10mm
RB6622	Up	4¾" (12.1cm)	3 × 10mm
RB6623	Down	4¾" (12.1cm)	3 × 10mm

Bayonet Spurling IVD Rongeurs

Catalog#	Description	Working Length	Bite
RB6641	Straight	4¾" (12.1cm)	4 × 10mm
RB6642	Up	4¾" (12.1cm)	4 × 10mm
RB6643	Down	4¾" (12.1cm)	4 × 10mm

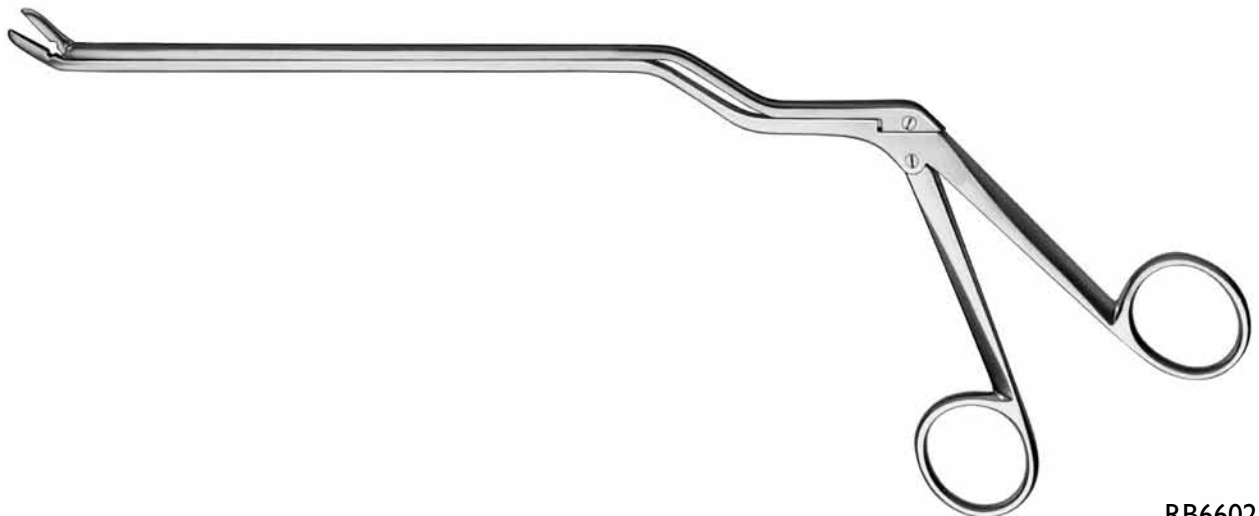

RB6602

Ultra-Coat™ Micro Kerrison Rongeur

Small, Improved Handle, Thin Footplate

- Coated with an extremely hard material that reduces wear
- Coating greatly reduces the frequency of sharpening and lowers replacement costs
- The surface smoothness enhances the sliding action
- Features a unique thin footplate design that facilitates easy insertion, without compromising tip strength

9mm Jaw Opening

Cutting Angle	Bite Size	7" (178mm)	8" (203mm)	9" (229mm)	10" (254mm)	11" (280mm)
40° Up	1mm	RB5760	RB5860	RB5960		
40° Up	1.5mm	RB5761	RB5861	RB5961		
40° Up	2mm	RB5762	RB5862	RB5962	RB5062	RB5162
40° Up	3mm	RB5763X	RB5863	RB5963	RB5063	RB5163
40° Up	4mm	RB5764X	RB5864	RB5964	RB5064	RB5164
40° Up	5mm	RB5765	RB5865	RB5965	RB5065	RB5165
40° Up	6mm	RB5766	RB5866	RB5966	RB5066	RB5166



Stealth™ Micro Kerrison Rongeurs

Small, Improved Handle, Thin Footplate

The “Stealth™” surface is a proprietary surface treatment intended to reduce the friction between metal surfaces, which makes the kerrison’s gliding action smoother and last longer. The dark surface also decreases the glare from the operating room lights.



RB4755

9mm Jaw Opening

Cutting Angle	Bite Size	7" (178mm)	8" (203mm)	9" (229mm)	10" (254mm)	11" (279mm)
40° Up	1mm	RB4771	RB4891	RB4991	RB41091	RB41191
40° Up	1.5mm	RB4751	RB4851	RB4951	RB41051	RB41151
40° Up	2mm	RB4752	RB4882	RB4952	RB41052	RB41152
40° Up	3mm	RB4753	RB4853	RB4953	RB41053	RB41153
40° Up	4mm	RB4754	RB4854	RB4954	RB41054	RB41154
40° Up	5mm	RB4755	RB4855	RB4955	RB41055	RB41155
40° Up	6mm	RB4756	RB4856	RB4956	RB41056	RB41156
40° Down	1mm		RB4890			
40° Down	2mm		RB4892			
40° Down	3mm		RB4863			
40° Down	4mm		RB4864			
40° Down	5mm		RB4865			
40° Down	6mm		RB4866			
90° Up	1mm		RB4861			
90° Up	2mm		RB4862			
90° Up	3mm		RB4833			
90° Up	4mm		RB4834			
90° Up	5mm		RB4835			
90° Up	6mm		RB4836			
90° Down	1mm		RB4860			
90° Down	2mm		RB4872			
90° Down	3mm		RB4843			
90° Down	4mm		RB4844			
90° Down	5mm		RB4845			
90° Down	6mm		RB4846			



Diamond™ Micro Kerrison Rongeurs

Small, Improved Handle, Thin Footplate

"Diamond™" is a specific ceramic coating that was developed to make the surface harder, therefore prolonging the life of the cutting edge of the kerrison. It also reduces the glare from the operating room lights while providing durability and smoother gliding action.

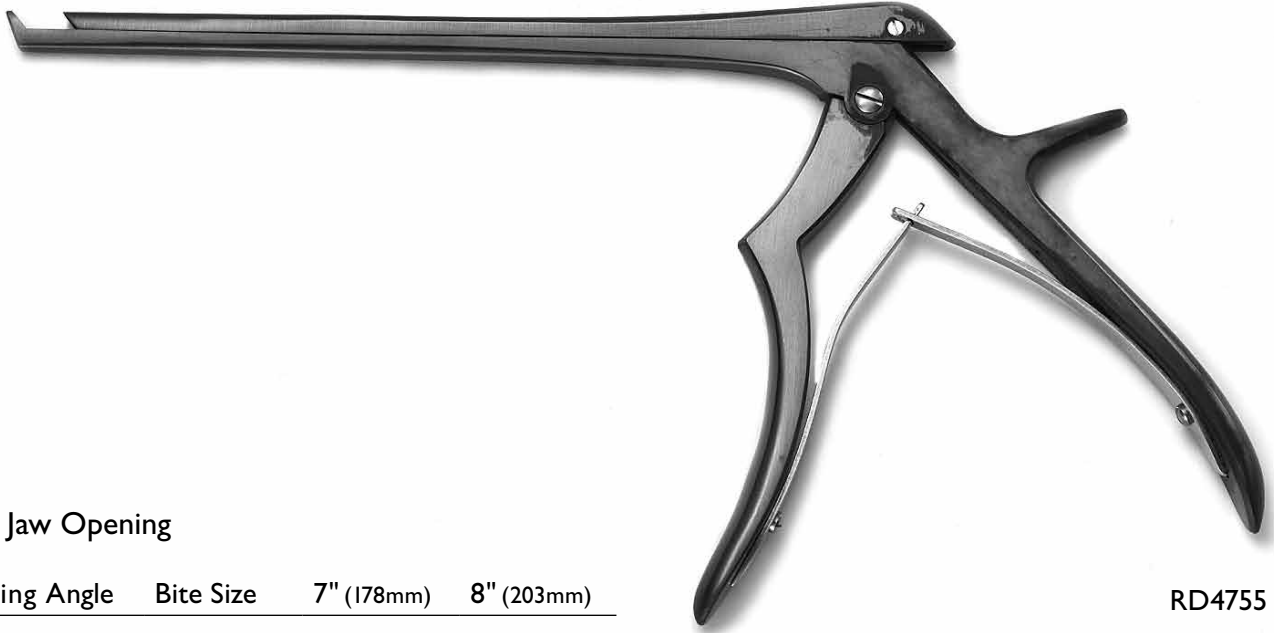

RD4755

9mm Jaw Opening

Cutting Angle	Bite Size	7" (178mm)	8" (203mm)
40° Up	1mm	RD4771	RD4891
40° Up	1.5mm	RD4751	RD4851
40° Up	2mm	RD4752	RD4882
40° Up	3mm	RD4753	RD4853
40° Up	4mm	RD4754	RD4854
40° Up	5mm	RD4755	RD4855
40° Up	6mm	RD4756	RD4856

Micro Kerrison Rongeurs
Small, Improved Handle, Thin Footplate



RN4752

9mm Jaw Opening

Cutting Angle	Bite Size	7" (178mm)	8" (203mm)	9" (229mm)	10" (254mm)	11" (279mm)
40° Up	1mm	RN4771	RN4891	RN4991	RN41091	RN41191
40° Up	1.5mm	RN4751	RN4851	RN4951	RN41051	RN41151
40° Up	2mm	RN4752	RN4882	RN4952	RN41052	RN41152
40° Up	3mm	RN4753	RN4853	RN4953	RN41053	RN41153
40° Up	4mm	RN4754	RN4854	RN4954	RN41054	RN41154
40° Up	5mm	RN4755	RN4855	RN4955	RN41055	RN41155
40° Up	6mm	RN4756	RN4856	RN4956	RN41056	RN41156
40° Down	1mm		RN4890			
40° Down	2mm		RN4892			
40° Down	3mm		RN4863			
40° Down	4mm		RN4864			
40° Down	5mm		RN4865			
40° Down	6mm		RN4866			
90° Up	1mm		RN4861			
90° Up	2mm		RN4862			
90° Up	3mm		RN4833			
90° Up	4mm		RN4834			
90° Up	5mm		RN4835			
90° Up	6mm		RN4836			
90° Down	1mm		RN4860			
90° Down	2mm		RN4872			
90° Down	3mm		RN4843			
90° Down	4mm		RN4844			
90° Down	5mm		RN4845			
90° Down	6mm		RN4846			



Ultra-Coat™ Bayonet Kerrisons

- Coated with an extremely hard material that reduces wear
- Coating greatly reduces the frequency of sharpening and lowers replacement costs
- The surface smoothness enhances the sliding action
- Features a unique thin footplate design that facilitates easy insertion, without compromising tip strength

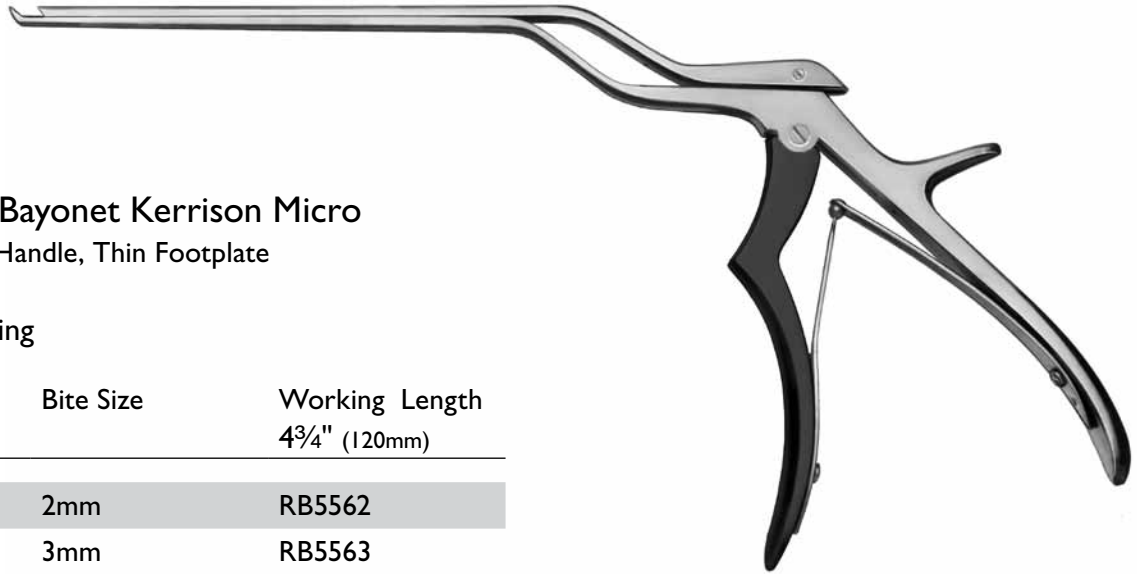

RB5563

Ultra-Coat™ Bayonet Kerrison Micro

Small, Improved Handle, Thin Footplate

9mm Jaw Opening

Cutting Angle	Bite Size	Working Length 4 ³ / ₄ " (120mm)
40° Up	2mm	RB5562
40° Up	3mm	RB5563
40° Up	4mm	RB5564
40° Up	5mm	RB5565
40° Up	6mm	RB5566

Ultra-Coat™ Bayonet Ejector Kerrison Micro

Small, Improved Handle, Thin Footplate

9mm Jaw Opening

Cutting Angle	Bite Size	Working Length 4 ³ / ₄ " (120mm)
40° Up	2mm	RB5582
40° Up	3mm	RB5583
40° Up	4mm	RB5584
40° Up	5mm	RB5585
40° Up	6mm	RB5586

Stealth™ Medium Kerrison Rongeurs

Small, Improved Handle, Thin Footplate

The “Stealth™” surface is a proprietary surface treatment intended to reduce the friction between metal surfaces, which makes the kerrison’s gliding action smoother and last longer. The dark surface also decreases the glare from the operating room lights.



RB4822M

15mm Jaw Opening

Cutting Angle	Bite Size	7" (178mm)	8" (203mm)
40° Up	1mm	RB4721M	RB4821M
40° Up	1.5mm	RB4751M	RB4851M
40° Up	2mm	RB4722M	RB4822M
40° Up	3mm	RB4723M	RB4823M
40° Up	4mm	RB4724M	RB4824M
40° Up	5mm	RB4725M	RB4825M
40° Up	6mm	RB4726M	RB4826M



Diamond™ Medium Kerrison Rongeur

Small, Improved Handle, Thin Footplate

"Diamond™" is a specific ceramic coating that was developed to make the surface harder, therefore prolonging the life of the cutting edge of the kerrison. It also reduces the glare from the operating room lights while providing durability and smoother gliding action.



RD4822M

15mm Jaw Opening

Cutting Angle	Bite Size	8" (203mm)
40° Up	1mm	RD4821M
40° Up	1.5mm	RD4851M
40° Up	2mm	RD4822M
40° Up	3mm	RD4823M
40° Up	4mm	RD4824M
40° Up	5mm	RD4825M
40° Up	6mm	RD4826M

Medium Kerrison Rongeurs
Small, Improved Handle, Thin Footplate



15mm Jaw Opening

Cutting Angle	Bite Size	7" (178mm)	8" (203mm)
40° Up	1mm	RN4721M	RN4821M
40° Up	1.5mm	RN4751M	RN4851M
40° Up	2mm	RN4722M	RN4822M
40° Up	3mm	RN4723M	RN4823M
40° Up	4mm	RN4724M	RN4824M
40° Up	5mm	RN4725M	RN4825M
40° Up	6mm	RN4726M	RN4826M

RN4822M



Ultra-Coat™ Spurling Kerrison Rongeur

Large, Improved Handle, Thin Footplate

- Coated with an extremely hard material that reduces wear
- Coating greatly reduces the frequency of sharpening and lowers replacement costs
- The surface smoothness enhances the sliding action
- Features a unique thin footplate design that facilitates easy insertion, without compromising tip strength

15mm Jaw Opening

Cutting Angle	Bite Size	7" (178mm)	8" (203mm)	9" (229mm)	10" (254mm)	11" (280mm)
40° Up	2mm	RB5772	RB5872	RB5972	RB5072	RB5172
40° Up	3mm	RB5773	RB5873	RB5973	RB5073	RB5173
40° Up	4mm	RB5774	RB5874	RB5974	RB5074	RB5174
40° Up	5mm	RB5775	RB5875	RB5975	RB5075	RB5175
40° Up	6mm	RB5776	RB5876	RB5976	RB5076	RB5176



RB5774

Stealth™ Spurling Kerrison Rongeur

Large, Improved Handle, Thin Footplate

The “Stealth™” surface is a proprietary surface treatment intended to reduce the friction between metal surfaces, which makes the kerrison’s gliding action smoother and last longer. The dark surface also decreases the glare from the operating room lights.



RB4823

15mm Jaw Opening

Cutting Angle	Bite Size	7" (178mm)	8" (203mm)	9" (229mm)	10" (254mm)	11" (279mm)
40° Up	2mm	RB4722	RB4822	RB4922	RB41022	RB41122
40° Up	3mm	RB4723	RB4823	RB4923	RB41023	RB41123
40° Up	4mm	RB4724	RB4824	RB4924	RB41024	RB41124
40° Up	5mm	RB4725	RB4825	RB4925	RB41025	RB41125
40° Up	6mm	RB4726	RB4826	RB4926	RB41026	RB41126
90° Up	2mm		RB4802			
90° Up	3mm		RB4803			
90° Up	4mm		RB4804			
90° Up	5mm		RB4805			
90° Up	6mm		RB4806			
90° Down	2mm		RB4812			
90° Down	3mm		RB4813			
90° Down	4mm		RB4814			
90° Down	5mm		RB4815			
90° Down	6mm		RB4816			

Diamond™ Spurling Kerrison Rongeur

Large, Improved Handle, Thin Footplate

"Diamond™" is a specific ceramic coating that was developed to make the surface harder, therefore prolonging the life of the cutting edge of the kerrison. It also reduces the glare from the operating room lights while providing durability and smoother gliding action.



RD4823

15mm Jaw Opening

Cutting Angle	Bite Size	7" (178mm)	8" (203mm)
40° Up	2mm	RD4722	RD4822
40° Up	3mm	RD4723	RD4823
40° Up	4mm	RD4724	RD4824
40° Up	5mm	RD4725	RD4825
40° Up	6mm	RD4726	RD4826

Spurling Kerrison Rongeur
Large, Improved Handle, Thin Footplate



RN4622

15mm Jaw Opening

Cutting Angle	Bite Size	7" (178mm)	8" (203mm)	9" (229mm)	10" (254mm)	11" (280mm)
40° Up	2mm	RN4722	RN4822	RN4922	RN41022	RN41122
40° Up	3mm	RN4723	RN4823	RN4923	RN41023	RN41123
40° Up	4mm	RN4724	RN4824	RN4924	RN41024	RN41124
40° Up	5mm	RN4725	RN4825	RN4925	RN41025	RN41125
40° Up	6mm	RN4726	RN4826	RN4926	RN41026	RN41126
90° Up	2mm		RN4802			
90° Up	3mm		RN4803			
90° Up	4mm		RN4804			
90° Up	5mm		RN4805			
90° Up	6mm		RN4806			
90° Down	2mm		RN4812			
90° Down	3mm		RN4813			
90° Down	4mm		RN4814			
90° Down	5mm		RN4815			
90° Down	6mm		RN4816			



Spurling Kerrison Rongeur
Cherry Handle, Thin Footplate

15mm Jaw Opening

Cutting Angle	Bite Size	7" (178mm)	8" (203mm)
40° Up	2mm	RN4722X	RN4822X
40° Up	3mm	RN4723X	RN4823X
40° Up	4mm	RN4724X	RN4824X
40° Up	5mm	RN4725X	RN4825X
40° Up	6mm	RN4726X	RN4826X

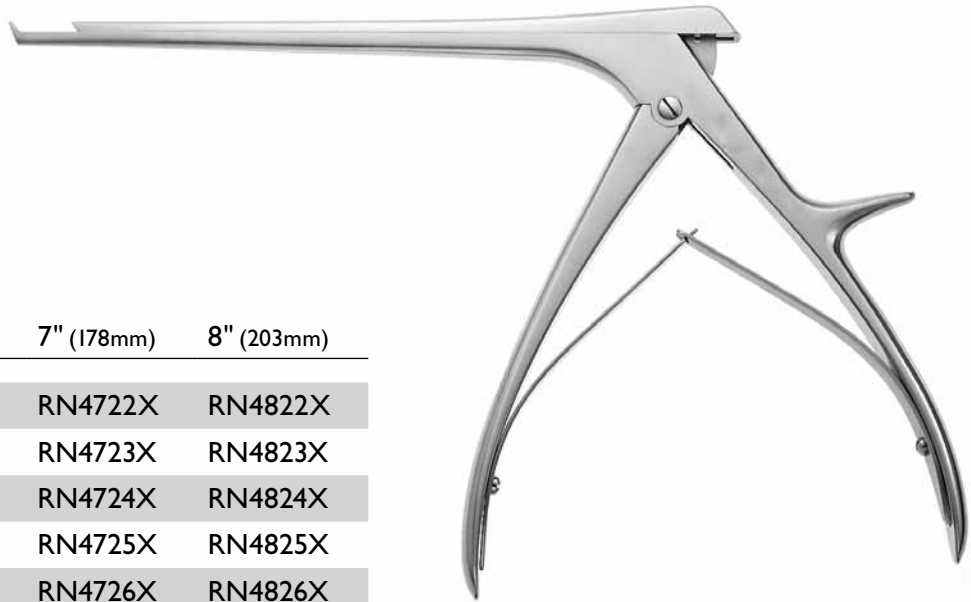

RN4723X

Open-Handle Kerrison Rongeur

9mm Jaw Opening

Catalog#	Cutting Angle	Length	Bite Size
RI587	40° Up	7" (178mm)	2mm
RI591	40° Up	7" (178mm)	3mm
RI593	40° Up	7" (178mm)	4mm
RI596	40° Up	7" (178mm)	5mm

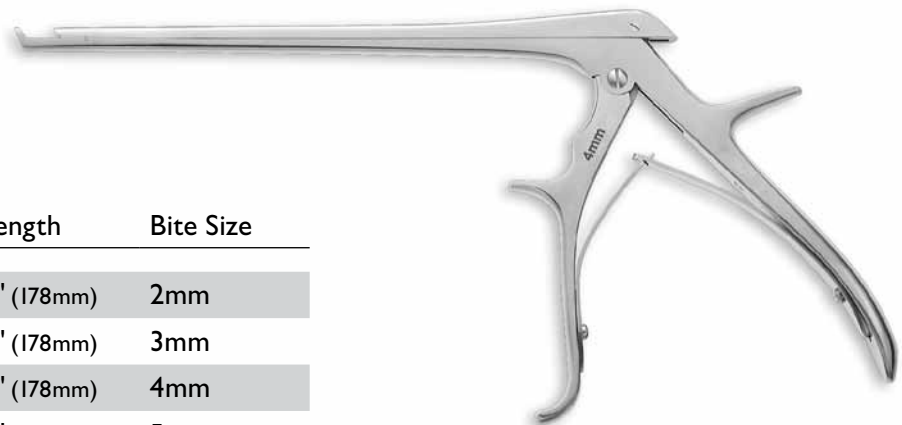

RI593

Stealth™ Ferris Smith Kerrison Rongeurs

Thin Footplate

The “Stealth™” surface is a propriety surface treatment intended to reduce the friction between metal surfaces, which makes the kerrison’s gliding action smoother and last longer. The dark surface also decreases the glare from the operating room lights.

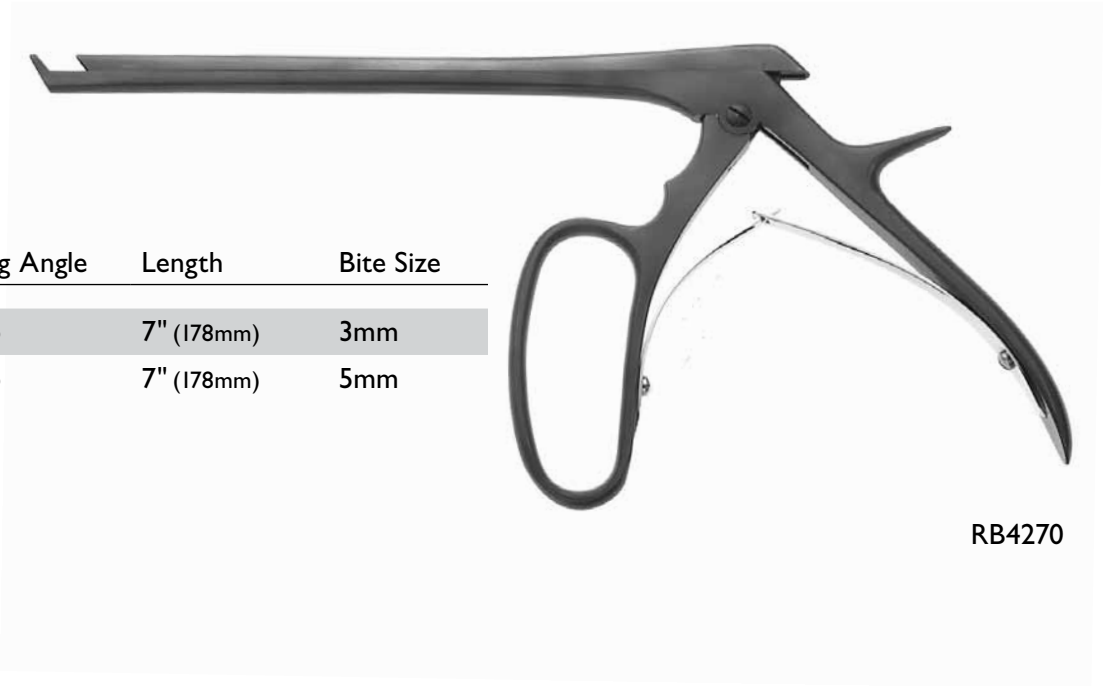

RB4270

9mm Jaw Opening

Catalog#	Cutting Angle	Length	Bite Size
RB4719	40° Up	7" (178mm)	3mm
RB4720	40° Up	7" (178mm)	5mm

Ferris-Smith Kerrison Rongeur

Thin Footplate

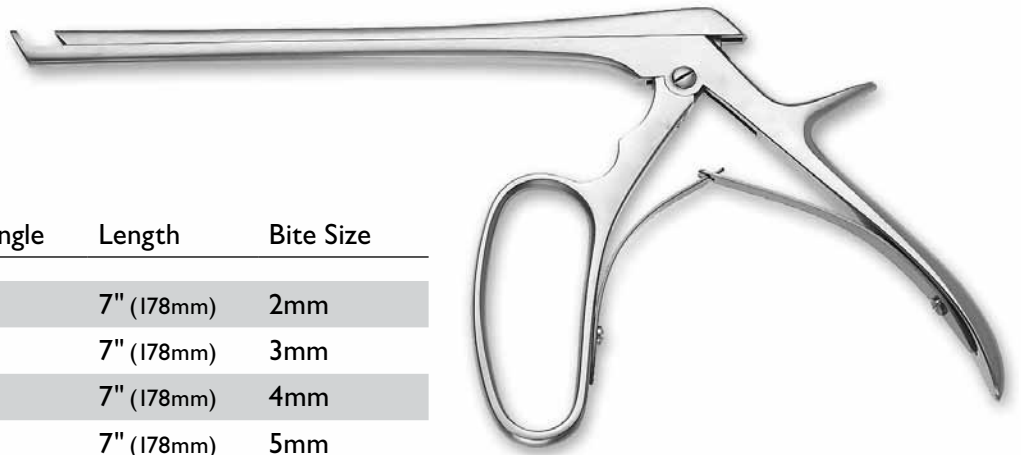

RN4720

9mm Jaw Opening

Catalog#	Cutting Angle	Length	Bite Size
RN4737	40° Up	7" (178mm)	2mm
RN4719	40° Up	7" (178mm)	3mm
RN4739	40° Up	7" (178mm)	4mm
RN4720	40° Up	7" (178mm)	5mm
RB3892	40° Up	8" (203mm)	2mm
RN4819	40° Up	8" (203mm)	3mm
RB3894	40° Up	8" (203mm)	4mm
RB3895	40° Up	8" (203mm)	5mm



Ultra-Coat™ Micro Ejector Kerrison Rongeur
Small, Improved Handle, Thin Footplate, Pin Ejector

9mm Jaw Opening

Bite Size	8" (203mm)	Cutting Angle
2mm	RB5882	40° Up
3mm	RB5883	40° Up
4mm	RB5884	40° Up
5mm	RB5885	40° Up



RB5884

Stealth™ Micro Ejector Kerrison Rongeur
Small, Improved Handle, Thin Footplate, Pin Ejector

9mm Jaw Opening

Catalog#	Cutting Angle	Length	Bite Size
RB4892E	40° Up	8" (203mm)	2mm
RB4893	40° Up	8" (203mm)	3mm
RB4894	40° Up	8" (203mm)	4mm
RB4895	40° Up	8" (203mm)	5mm
RB4896	40° Up	8" (203mm)	6mm

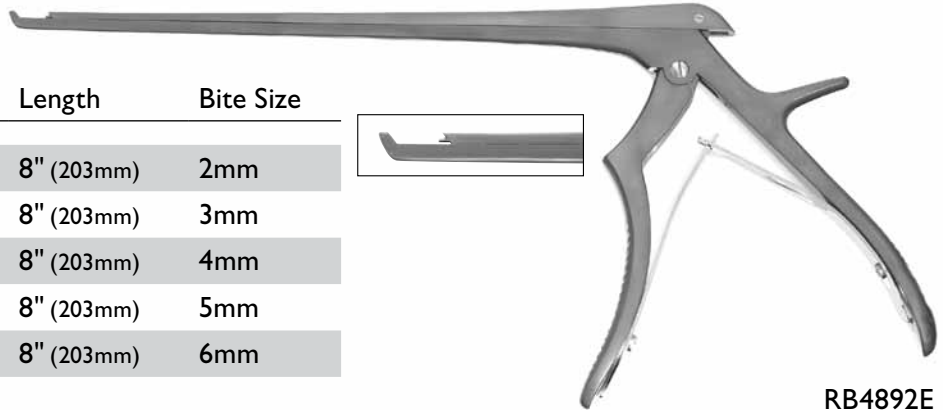

RB4892E

Micro Ejector Kerrison Rongeur
Small, Improved Handle, Thin Footplate, Pin Ejector

9mm Jaw Opening

Catalog#	Cutting Angle	Length	Bite Size
RN4892E	40° Up	8" (203mm)	2mm
RN4893	40° Up	8" (203mm)	3mm
RN4894	40° Up	8" (203mm)	4mm
RN4895	40° Up	8" (203mm)	5mm
RN4896	40° Up	8" (203mm)	6mm

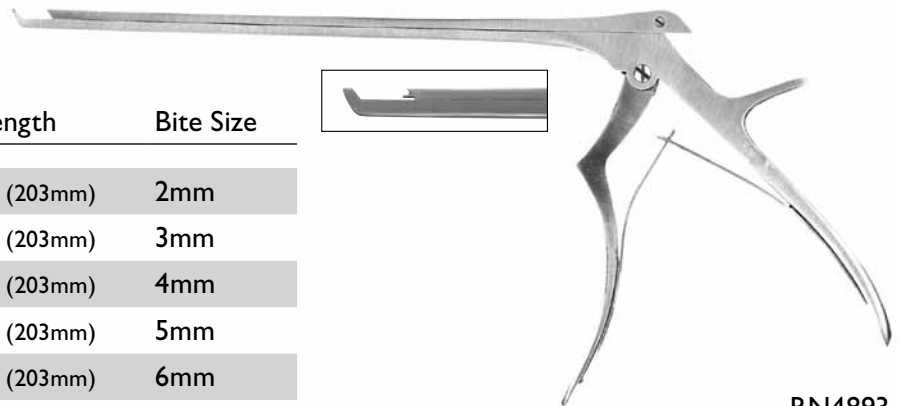

RN4893



Micro Ejector Kerrison Rongeur
Bar Ejector

9mm Jaw Opening

Catalog#	Cutting Angle	Length	Bite Size
RI635	40° Up	8" (203mm)	2mm
RI636	40° Up	8" (203mm)	3mm
RI637	40° Up	8" (203mm)	4mm
RI638	40° Up	8" (203mm)	5mm



RI636

Spurling Ejector Kerrison Rongeur
Bar Ejector

15mm Jaw Opening

Catalog#	Cutting Angle	Length	Bite Size
RI6403	40° Up	8" (203mm)	3mm
RI6404	40° Up	8" (203mm)	4mm
RI6405	40° Up	8" (203mm)	5mm

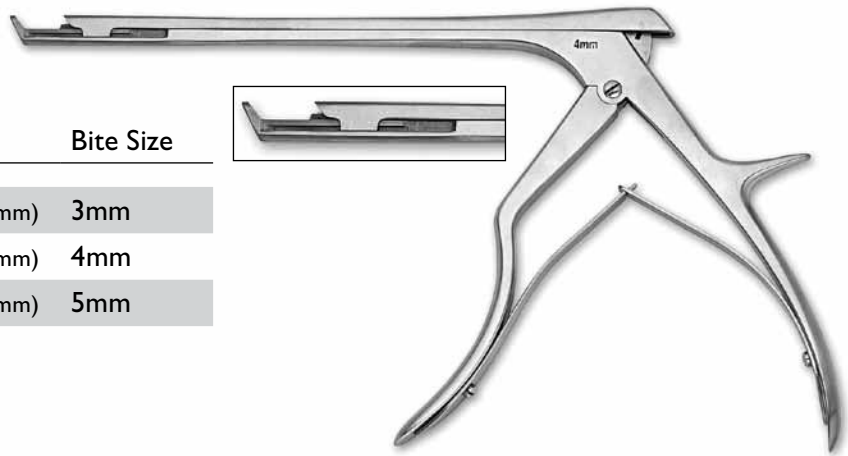

RI6404

Micro Curved Kerrison Rongeur Hinged



40° Up



90° Up



90° Down

9mm Jaw Opening

Catalog#	Cutting Angle	Length	Bite Size
R16702	Curved Up	8" (203mm)	2mm
R16703	Curved Up	8" (203mm)	3mm
R16704	Curved Up	8" (203mm)	4mm
R16705	Curved Up	8" (203mm)	5mm
R16706	Curved Up	8" (203mm)	6mm
R16703L	Curved Left	8" (203mm)	3mm
R16703R	Curved Right	8" (203mm)	3mm



R16703

Stealth™ Hingeless Curved Kerrison Rongeur



Curved Down

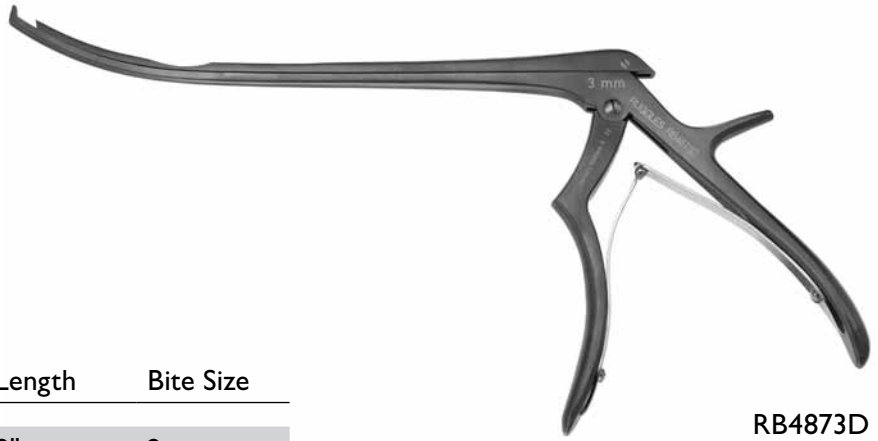

RB4873D

9mm Jaw Opening

Catalog#	Cutting Angle	Length	Bite Size
RB4872D	Curved Up	8" (203mm)	2mm
RB4873D	Curved Up	8" (203mm)	3mm
RB4874D	Curved Up	8" (203mm)	4mm
RB4875D	Curved Up	8" (203mm)	5mm

Hingeless Curved Kerrison Rongeur



Curved Up



RN4872D

9mm Jaw Opening

Catalog#	Cutting Angle	Length	Bite Size
RN4872D	Curved Up	8" (203mm)	2mm
RN4873D	Curved Up	8" (203mm)	3mm
RN4874D	Curved Up	8" (203mm)	4mm
RN4875D	Curved Up	8" (203mm)	5mm



Kerrison Instrument Tray

Catalog#	Description
RBT1001	Holds 8 Kerrisons



RBT1001





CURETTES

Curette Cup Size (mm), 6-0 thru #6

Size:	6-0	5-0	4-0	3-0	2-0	1-0	#1	#2	#3	#4	#5	#6
W x L	1.3 x 2	1.5 x 2.5	2 x 3	2.5 x 4	3 x 4.5	3.5 x 5.5	4.5 x 7	5 x 8	5.5 x 9	7.5 x 11	9 x 13	10 x 15
	0	0	0	0	0	0	0	0	0	0	0	0

Ultra-Coat™ Spinal Curettes

Straight

Description	Cup Size	6¾" (171mm)	8" (203mm)	9" (229mm)	12" (305mm)
Straight	5-0	RB7701	RB7712	RB7723	RB7734
Straight	4-0	RB7702	RB7713	RB7724	RB7735
Straight	3-0	RB7703	RB7714	RB7725	RB7736
Straight	2-0	RB7704	RB7715	RB7726	RB7737
Straight	1-0	RB7705	RB7716	RB7727	RB7738
Straight	1	RB7706	RB7717	RB7728	RB7739
Straight	2	RB7707	RB7718	RB7729	RB7740
Straight	3	RB7708	RB7719	RB7730	RB7741
Straight	4	RB7709	RB7720	RB7731	RB7742
Straight	5	RB7710	RB7721	RB7732	RB7743
Straight	6	RB7711	RB7722	RB7733	RB7744



Ultra-Coat™ Spinal Curettes

Reverse Angle

Description	Cup Size	8" (203mm)	9" (229mm)	12" (305mm)
Reverse Angled	5-0	RB7801	RB7812	RB7823
Reverse Angled	4-0	RB7802	RB7813	RB7824
Reverse Angled	3-0	RB7803	RB7814	RB7825
Reverse Angled	2-0	RB7804	RB7815	RB7826
Reverse Angled	1-0	RB7805	RB7816	RB7827
Reverse Angled	1	RB7806	RB7817	RB7828
Reverse Angled	2	RB7807	RB7818	RB7829
Reverse Angled	3	RB7808	RB7819	RB7830
Reverse Angled	4	RB7809	RB7820	RB7831
Reverse Angled	5	RB7810	RB7821	RB7832
Reverse Angled	6	RB7811	RB7822	RB7833



Curette Cup Size (mm), 6-0 thru #6

Size:	6-0	5-0	4-0	3-0	2-0	1-0	#1	#2	#3	#4	#5	#6
W x L	1.3 x 2	1.5 x 2.5	2 x 3	2.5 x 4	3 x 4.5	3.5 x 5.5	4.5 x 7	5 x 8	5.5 x 9	7.5 x 11	9 x 13	10 x 15
	0	0	0	0	0	0	0	0	0	0	0	0

Ultra-Coat™ Spinal Curettes

Angled

Description	Cup Size	8" (203mm)	9" (229mm)	12" (305mm)
Angled	5-0	RB7745	RB7756	RB7767
Angled	4-0	RB7746	RB7757	RB7768
Angled	3-0	RB7747	RB7758	RB7769
Angled	2-0	RB7748	RB7759	RB7770
Angled	1-0	RB7749	RB7760	RB7771
Angled	1	RB7750	RB7761	RB7772
Angled	2	RB7751	RB7762	RB7773
Angled	3	RB7752	RB7763	RB7774
Angled	4	RB7753	RB7764	RB7775
Angled	5	RB7754	RB7765	RB7776
Angled	6	RB7755	RB7766	RB7777

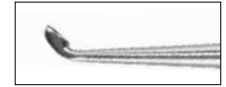

Angled



Reverse-Angled



Straight



Curette Cup Size (mm), 6-0 thru #6

Size:	6-0	5-0	4-0	3-0	2-0	1-0	#1	#2	#3	#4	#5	#6
W x L	1.3 x 2	1.5 x 2.5	2 x 3	2.5 x 4	3 x 4.5	3.5 x 5.5	4.5 x 7	5 x 8	5.5 x 9	7.5 x 11	9 x 13	10 x 15
	0	0	0	0	0	0	0	0	0	0	0	0

Spinal Fusion Curettes
Standard Cup, Hollow Handles
Straight

Description	Cup Size	6¾" (171mm)	8" (203mm)	9" (229mm)	12" (305mm)
Straight	5-0	RN06001	RE0800	RN0900	RN01200
Straight	4-0	RN0600	RE0801	RN0901	RN01201
Straight	3-0	RN0601	RE0802	RN0902	RN01202
Straight	2-0	RN0602	RE0803	RN0903	RN01203
Straight	1-0	RN0603	RE0804	RN0904	RN01204
Straight	#1	RN0604	RE0805	RN0905	RN01205
Straight	#2	RN0605	RE0806	RN0906	RN01206
Straight	#3	RN0606	RE0807	RN0907	RN01207
Straight	#4	RN0607	RE0808	RN0908	RN01208
Straight	#5	RN0608	RE0809	RN0909	RN01209
Straight	#6	RN0609	RE0810	RN0910	RN01210

Spinal Fusion Curettes
Standard Cup, Hollow Handles
Angled

Description	Cup Size	6¾" (171mm)	8" (203mm)	9" (229mm)	12" (305mm)
Angled	5-0		RE0820	RN0920	RN01220
Angled	4-0		RE0821	RN0921	RN01221
Angled	3-0	R0360B	RE0822	RN0922	RN01222
Angled	2-0	R0361B	RE0823	RN0923	RN01223
Angled	1-0	R0362B	RE0824	RN0924	RN01224
Angled	#1	R0363B	RE0825	RN0925	RN01225
Angled	#2	R0364B	RE0826	RN0926	RN01226
Angled	#3	R0365B	RE0827	RN0927	RN01227
Angled	#4	R0366B	RE0828	RN0928	RN01228
Angled	#5	R0367B	RE0829	RN0929	RN01229
Angled	#6	R0368B	RE0830	RN0930	RN01230



RN0601



RN0923

Curette Cup Size (mm), 6-0 thru #6

Size:	6-0	5-0	4-0	3-0	2-0	1-0	#1	#2	#3	#4	#5	#6
W x L	1.3 x 2	1.5 x 2.5	2 x 3	2.5 x 4	3 x 4.5	3.5 x 5.5	4.5 x 7	5 x 8	5.5 x 9	7.5 x 11	9 x 13	10 x 15
	0	0	0	0	0	0	0	0	0	0	0	0

Spinal Fusion Curettes

Standard Cup, Hollow Handles

Reverse Angled

Description	Cup Size	8" (203mm)	9" (229mm)	12" (305mm)
Reverse Angled	5-0	RE0848	RN0948	RN01248
Reverse Angled	4-0	RE0849	RN0949	RN01249
Reverse Angled	3-0	RE0850	RN0950	RN01250
Reverse Angled	2-0	RE0851	RN0951	RN01251
Reverse Angled	1-0	RE0852	RN0952	RN01252
Reverse Angled	#1	RE0853	RN0953	RN01253
Reverse Angled	#2	RE0854	RN0954	RN01254
Reverse Angled	#3	RE0855	RN0955	RN01255
Reverse Angled	#4	RE0856	RN0956	RN01256
Reverse Angled	#5	RE0857	RN0957	RN01257
Reverse Angled	#6	RE0858	RN0958	RN01258



RN0954

Spinal Fusion Curette Tray

- R8113 Single Level
Holds 10- 9" Curettes
- R8114 Double Level
Holds 20- 9" Curettes
- RS0900 Single Level
Holds 12- 8" or 9" Curettes
- RBT1002 Single Level
Holds 12- 8" or 9" Curettes



R8114



RS0900



RBT1002

Curette Cup Size (mm), 6-0 thru #6

Size:	6-0	5-0	4-0	3-0	2-0	1-0	#1	#2	#3	#4	#5	#6
W x L	1.3 x 2	1.5 x 2.5	2 x 3	2.5 x 4	3 x 4.5	3.5 x 5.5	4.5 x 7	5 x 8	5.5 x 9	7.5 x 11	9 x 13	10 x 15
	0	0	0	0	0	0	0	0	0	0	0	0

The design of the RUGGLES™ Flatback Curettes has eliminated the bulk at the back of the curette thus allowing the curette to become more maneuverable and efficient in the removing of the disc material.

Flatback Spinal Fusion Curettes

Standard Cup, Hollow Handles, 9" (229mm)

Cup Size	Straight	Angled 40°	Angled 90°	Reverse-Angle
6-0	R2799	R2819	R2839	RB7170
5-0	R2800	R2820	R2840	R2850
4-0	R2801	R2821	R2841	R2851
3-0	R2802	R2822	R2842	R2852
2-0	R2803	R2823	R2843	R2853
1-0	R2804	R2824	R2844	R2854
#1	R2805	R2825	R2845	R2855
#2	R2806	R2826	R2846	R2856
#3	R2807	R2827	R2847	R2857
#4	R2808	R2828	R2848	R2858
#5	R2809	R2829	R2849	R2859
#6	R2810	R2830	RB7281	RB7181



R2805



R2825



Curette Cup Size (mm), 6-0 thru #6

Size:	6-0	5-0	4-0	3-0	2-0	1-0	#1	#2	#3	#4	#5	#6
W x L	1.3 x 2	1.5 x 2.5	2 x 3	2.5 x 4	3 x 4.5	3.5 x 5.5	4.5 x 7	5 x 8	5.5 x 9	7.5 x 11	9 x 13	10 x 15
	0	0	0	0	0	0	0	0	0	0	0	0

Ultra-Coat™ Flatback Currettes

9" (229mm)

Cup Size	Straight	Angled	Angled 90°	Reverse Angle
6-0	RB7900	RB7920	RB7940	RB7960
5-0	RB7901	RB7921	RB7941	RB7961
4-0	RB7902	RB7922	RB7942	RB7962
3-0	RB7903	RB7923	RB7943	RB7963
2-0	RB7904	RB7924	RB7944	RB7964
1-0	RB7905	RB7925	RB7945	RB7965
#1	RB7906	RB7926	RB7946	RB7966
#2	RB7907	RB7927	RB7947	RB7967
#3	RB7908	RB7928	RB7948	RB7968
#4	RB7909	RB7929	RB7949	RB7969
#5	RB7910	RB7930	RB7950	RB7970
#6	RB7911	RB7931	RB7951	RB7971

Flatback Curette

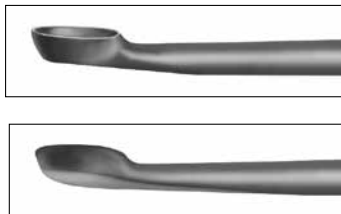

Regular Curette

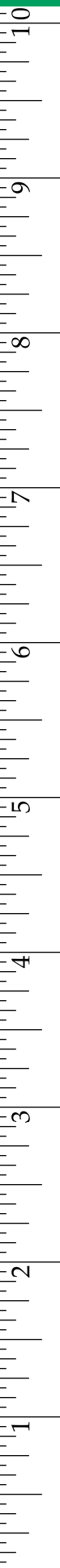
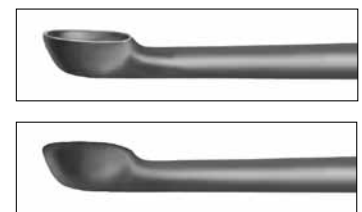

Spinal Fusion Currettes
Standard Cup, Hollow Handles
12" (305mm)

Cup Size	Cup Size	Straight	Angled
3-0	3.5 × 5mm	R2000	R2010
2-0	4 × 5.5mm	R2001	R2011
1-0	4.5 × 6.5mm	R2002	R2012
#1	5 × 7mm	R2003	R2013
#2	6 × 9.5mm	R2004	R2014
#3	7 × 11mm	R2005	R2015
#4	8.5 × 13mm	R2006	R2016
#5	9.5 × 14.5mm	R2007	R2017
#6	10.5 × 17mm	R2008	R2018



R2008



R2018

Spinal Fusion Curette Tray

R6523 Single Level
 Holds 14- 12" Currettes

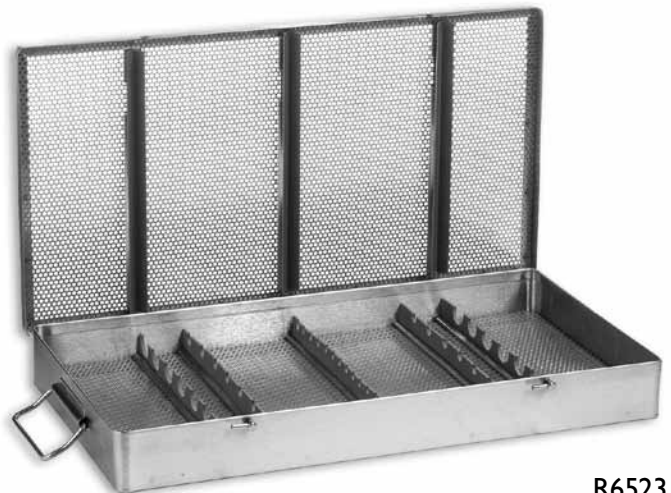

R6523



Scoville Ruptured Disc Curettes
Standard Cup, Hollow Handles
10" (254mm)

Catalog#	Description	Cup Size
RN0960	Straight	4 × 10mm
RN0961	Lateral	4 × 10mm
RN0962	Angled	4 × 10mm



RN0962



Thoraco-Lumbar Curettes

Resin Handles, 13½" (343mm)

Cup Size	Cup Size	Straight	Angled	Reverse-Angle
2-0	3 × 4.5mm	R6513	R6517	R6521
1-0	3.5 × 5mm	R6512	R6516	R6520
#1	4 × 7mm	R6511	R6515	R6519
#2	5 × 7.5mm	R6510	R6514	R6518



Angled, R6516



Reverse-Angle, R6518



Straight, R6513

Thoraco-Lumbar Dissectors

Angled, 13½" (343mm)

Catalog#	Description
R6506	Large
R6507	Small



Dissector-Angle, R6507

Apfelbaum Extended Reach Curettes

Aluminum Handles

Angled

Cup Size	Cup Size	Reach	12" (305mm)	14½" (368mm)	Handle Color
4-0	2 × 3mm	5mm	RN1171	RN1181	Red
4-0	2 × 3mm	6mm	RN1172	RN1182	Blue
4-0	2 × 3mm	7mm	RN1173	RN1183	Gold

RN1170 12" Set including items RN1171, RN1172, and RN1173
 RN1180 14½" Set including items RN1181, RN1182, and RN1183



RN1171

Cobb Style Bone Curettes

Solid, Knurled Handle

11" (279mm)

Cup Size	Cup Size	Straight	Angled
3-0	2 × 3.5mm	R2220	R2230
2-0	2.5 × 4.5mm	R2221	R2231
1-0	3 × 5mm	R2222	R2232
#1	3.5 × 6mm	R2223	R2233
#2	4.5 × 7.5mm	R2224	R2234
#3	5.5 × 9mm	R2225	R2235
#4	7.5 × 11.5mm	R2226	R2236
#5	8.5 × 12.5mm	R2227	R2237
#6	10 × 15mm	R2228	R2238



R2220



R2234

Epstein Curettes

Standard, Hollow Handle, Reverse Angle

8" (203mm)

Catalog#	Cup Size
RN0820	3-0
RN0821	2-0
RN0822	1-0



RN0820

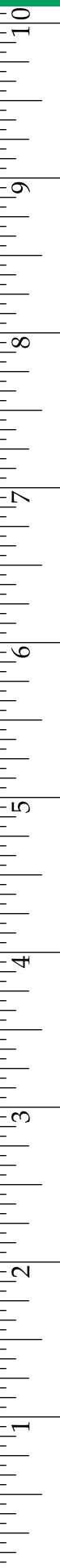

Curette Cup Size (mm), 6-0 thru #6

Size:	6-0	5-0	4-0	3-0	2-0	1-0	#1	#2	#3	#4	#5	#6
W x L	1.3 x 2	1.5 x 2.5	2 x 3	2.5 x 4	3 x 4.5	3.5 x 5.5	4.5 x 7	5 x 8	5.5 x 9	7.5 x 11	9 x 13	10 x 15
	0	0	0	0	0	0	0	0	0	0	0	0

Micro-Angled Curettes

Standard, Hollow Handle

9" (229mm)

Cup Size	Straight	Angled
5-0	RN0981	RN0986
4-0	RN0982	RN0987
3-0	RN0983	RN0988



RN0986

Micro-Bayonet Curettes

Standard, Hollow Handle

9" (229mm)

Cup Size	Straight	Angled	Reverse-Angle
5-0	RN0881	RN0886	RN0897
4-0	RN0882	RN0887	RN0898
3-0	RN0883	RN0888	RN0899



RN0883



Round Bayonet Handle Micro Curettes
9½" (240mm)

Catalog#	Description
R7350	Straight
R7351	45° Angle
R7352	90° Angle
R7353	Curved Up



R7350

Catalog#	Angle	Stick	Cup
R7360	45° Up	5mm	3mm
R7361	45° Down	5mm	3mm
R7362	45° Right	5mm	3mm
R7363	45° Left	5mm	3mm
R7370	45° Up	10mm	3mm
R7371	45° Down	10mm	3mm
R7372	45° Right	10mm	3mm
R7373	45° Left	10mm	3mm



R7360



R7370

Catalog#	Angle	Stick	Cup
R7365	90° Up	5mm	3mm
R7366	90° Down	5mm	3mm
R7367	90° Right	5mm	3mm
R7368	90° Left	5mm	3mm



R7366

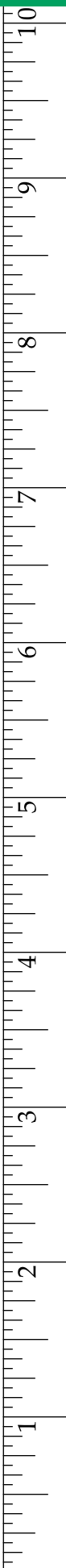



Cone Ring Curettes

Solid, Knurled Aluminum Handle

9" (229mm)

Catalog#	Length	Description	Ring Size
RN0991	9" (229mm)	Straight	8mm
RN0992	9" (229mm)	Straight	6mm
RN0993	9" (229mm)	Straight	3mm
RN0994	9" (229mm)	Angled	8mm
RN0995	9" (229mm)	Angled	6mm
RN0996	9" (229mm)	Angled	3mm



RN0992



RN0994

Semmes Spinal Fusion Curettes

Hollow Handle, Oval Ring

9" (229mm)

Catalog#	Ring Size	Description
RN0945	5 × 8mm	Straight
RN0946	5 × 8mm	Slightly Angled
RN0947	5 × 8mm	Fully Angled



RN0945

Curette Cup Size (mm), 6-0 thru #6

Size:	6-0	5-0	4-0	3-0	2-0	1-0	#1	#2	#3	#4	#5	#6
W x L	1.3 x 2	1.5 x 2.5	2 x 3	2.5 x 4	3 x 4.5	3.5 x 5.5	4.5 x 7	5 x 8	5.5 x 9	7.5 x 11	9 x 13	10 x 15
	0	0	0	0	0	0	0	0	0	0	0	0

Sisco Bayonet Curettes

Standard, Hollow Handle

9" (229mm), Working Length 1¾" (44mm)

Cup Size	Straight	40° Angle	90° Angle	Reverse-Angle Up	Reverse-Angle Down
6-0	R2871	R2891	R2870	R2865	R2881
5-0	R2872	R2892	R2860	R2866	R2882
4-0	R2873	R2893	R2861	R2867	R2883
3-0	R2874	R2894	R2862	R2868	R2884
2-0	R2875	R2895	R2863	R2877	R2885
1-0	R2876	R2896	R2864	R2878	R2886



Straight, R2872

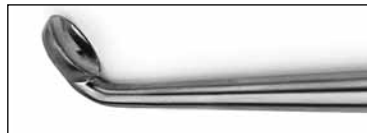

40° Angle, R2892



90° Angle, R2861



Reverse-Angle Up, R2867



Reverse-Angle Down, R2883

Spinal Fusion Curette Tray

R8113	Single Level Holds 9- 9" Bayonet Curettes
R8114	Double Level Holds 18- 9" Bayonet Curettes

Cervical Bayonet Curettes

8½" (216mm)



Catalog#

RR8100

Set includes one each of RR8110 through RR8133 plus two (2) each of RS0900 Trays

Catalog#	Description	Cup	Angle
RR8110	Curette	0	Forward-Straight
RR8111	Curette	00	Forward-Straight
RR8112	Curette	000	Forward-Straight
RR8113	Curette	0000	Forward-Straight
RR8114	Curette	00	Forward-Straight
RR8115	Curette	0	Forward-Angle
RR8116	Curette	00	Forward-Angle
RR8117	Curette	000	Forward-Angle
RR8118	Curette	0000	Forward-Angle
RR8119	Curette	00	Forward-Angle
RR8120	Curette	0	Backward-Straight
RR8121	Curette	00	Backward-Straight
RR8122	Curette	000	Backward-Straight
RR8123	Curette	0000	Backward-Straight
RR8124	Bone Cutter	00	Backward-Straight
RR8125	Curette	0	Backward-Angle
RR8126	Curette	00	Backward-Angle
RR8127	Curette	000	Backward-Angle
RR8128	Curette	0000	Backward-Angle
RR8129	Bone Cutter	00	Backward-Angle
RR8130	Nerve Hook		
RR8131	Ultra Nerve Hook		
RR8132	Bone Waxer		
RR8133	Knife Handle		

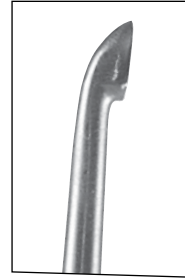

FORWARD STRAIGHT



FORWARD ANGLE



BACKWARD STRAIGHT



BACKWARD ANGLE

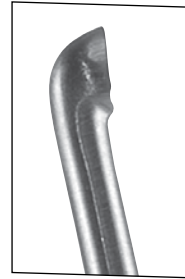

CORTICAL BONE CUTTING



NERVE HOOK



BONE WAXER



Cervical Bayonet Curettes, XL

9½ (241mm)



Catalog#

RR8200

Set includes one each of RR8210 through RR8232 and RR8133 two (2) each of RS0900 Trays

Catalog#	Description	Cup	Angle
RR8210	Curette	0	Forward-Straight
RR8211	Curette	00	Forward-Straight
RR8212	Curette	000	Forward-Straight
RR8213	Curette	0000	Forward-Straight
RR8214	Bone Cutter	00	Forward-Straight
RR8215	Curette	0	Forward-Angle
RR8216	Curette	00	Forward-Angle
RR8217	Curette	000	Forward-Angle
RR8218	Curette	0000	Forward-Angle
RR8219	Bone Cutter	00	Forward-Angle
RR8220	Curette	0	Backward-Straight
RR8221	Curette	00	Backward-Straight
RR8222	Curette	000	Backward-Straight
RR8223	Curette	0000	Backward-Straight
RR8224	Bone Cutter	00	Backward-Straight
RR8225	Curette	0	Backward-Angle
RR8226	Curette	00	Backward-Angle
RR8227	Curette	000	Backward-Angle
RR8228	Curette	0000	Backward-Angle
RR8229	Bone Cutter	00	Backward-Angle
RR8230	Nerve Hook		
RR8231	Ultra Nerve Hook		
RR8232	Bone Waxer		
RR8133	Knife Handle		



FORWARD STRAIGHT



FORWARD ANGLE



BACKWARD STRAIGHT



BACKWARD ANGLE

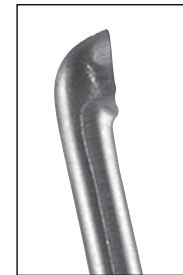

CORTICAL BONE CUTTING



NERVE HOOK

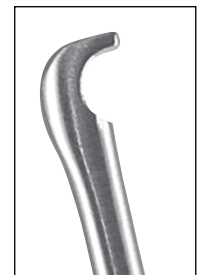

BONE WAXER



Lumbar Bayonet Curettes

9½ (241mm)



Catalog#

RR8000

Set includes one each of RR8010 through RR8055 plus two (2) each of RS0900 Trays

Catalog#	Description	Cup	Angle
RR8010	Curette	0	Forward-Straight
RR8011	Curette	#1	Forward-Straight
RR8012	Curette	#2	Forward-Straight
RR8013	Curette	0	Forward-Angle
RR8014	Curette	#1	Forward-Angle
RR8015	Curette	#2	Forward-Angle
RR8016	Curette	0	Forward-Down
RR8017	Curette	#1	Forward-Down
RR8018	Curette	#2	Forward-Down
RR8019	Curette	0	Backward-Straight
RR8020	Curette	#1	Backward-Straight
RR8021	Curette	#2	Backward-Straight
RR8022	Curette	0	Backward-Angle
RR8023	Curette	#1	Backward-Angle
RR8024	Curette	#2	Backward-Angle
RR8025	Curette	0	Backward-Down
RR8026	Curette	#1	Backward-Down
RR8027	Curette	#2	Backward-Down
RR8028	Penfield Dissector	#1	
RR8029	Penfield Dissector	#2	
RR8030	Nerve Hook		
RR8031	Penfield Dissector	#4	
RR8032	Bone Waxer		
RR8033	Spine Probe		



FORWARD STRAIGHT



FORWARD ANGLE



BACKWARD STRAIGHT



BACKWARD ANGLE



PENFIELD DISSECTOR



NERVE HOOK



BONE WAXER

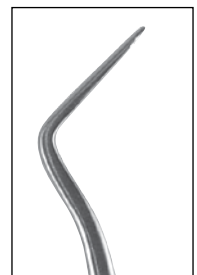

SPINE PROBE





SUCTION TUBES



	○	○	○	○	○	○	○	○	○	○	○
French	3 Fr	4 Fr	5 Fr	6 Fr	7 Fr	8 Fr	9 Fr	10 Fr	11 Fr	12 Fr	15 Fr
Inches	.039	.053	.066	.079	.092	.105	.118	.131	.144	.158	.197
Millimeters	1	1.35	1.67	2.0	2.3	2.7	3.0	3.3	3.7	4.0	5.0

Frazier Suction Tubes

Semi-Rigid with Hole

Straight

Catalog#	Working Length	Diameter
RN8563	5½" (140mm)	3 Fr
RN8564	5½" (140mm)	4 Fr
RN8565	5½" (140mm)	5 Fr
RN8566	5½" (140mm)	6 Fr
RN8567	5½" (140mm)	7 Fr
RN8568	5½" (140mm)	8 Fr
RN8569	5½" (140mm)	9 Fr
RN85610	5½" (140mm)	10 Fr
RN85611	5½" (140mm)	11 Fr
RN85612	5½" (140mm)	12 Fr
RN8763	7" (178mm)	3 Fr
RN8764	7" (178mm)	4 Fr
RN8765	7" (178mm)	5 Fr
RN8766	7" (178mm)	6 Fr
RN8767	7" (178mm)	7 Fr
RN8768	7" (178mm)	8 Fr
RN8769	7" (178mm)	9 Fr
RN87610	7" (178mm)	10 Fr
RN87611	7" (178mm)	11 Fr
RN87612	7" (178mm)	12 Fr

Angled

Catalog#	Working Length	Diameter
RN8583	4¼" (108mm)	3 Fr
RN8584	4¼" (108mm)	4 Fr
RN8585	4¼" (108mm)	5 Fr
RN8586	4¼" (108mm)	6 Fr
RN8587	4¼" (108mm)	7 Fr
RN8588	4¼" (108mm)	8 Fr
RN8589	4¼" (108mm)	9 Fr
RN85810	4¼" (108mm)	10 Fr
RN85811	4¼" (108mm)	11 Fr
RN85812	4¼" (108mm)	12 Fr
RN8783	5¾" (146mm)	3 Fr
RN8784	5¾" (146mm)	4 Fr
RN8785	5¾" (146mm)	5 Fr
RN8786	5¾" (146mm)	6 Fr
RN8787	5¾" (146mm)	7 Fr
RN8788	5¾" (146mm)	8 Fr
RN8789	5¾" (146mm)	9 Fr
RN87810	5¾" (146mm)	10 Fr
RN87811	5¾" (146mm)	11 Fr
RN87812	5¾" (146mm)	12 Fr



RN85612



RN85812

	○	○	○	○	○	○	○	○	○	○	○
French	3 Fr	4 Fr	5 Fr	6 Fr	7 Fr	8 Fr	9 Fr	10 Fr	11 Fr	12 Fr	15 Fr
Inches	.039	.053	.066	.079	.092	.105	.118	.131	.144	.158	.197
Millimeters	1	1.35	1.67	2.0	2.3	2.7	3.0	3.3	3.7	4.0	5.0

Frazier Suction Tubes

Semi-Rigid with Slot

Straight

Catalog#	Working Length	Diameter
RN8503	5½" (140mm)	3 Fr
RN8504	5½" (140mm)	4 Fr
RN8505	5½" (140mm)	5 Fr
RN8506	5½" (140mm)	6 Fr
RN8507	5½" (140mm)	7 Fr
RN8508	5½" (140mm)	8 Fr
RN8509	5½" (140mm)	9 Fr
RN8510	5½" (140mm)	10 Fr
RN8511	5½" (140mm)	11 Fr
RN8512	5½" (140mm)	12 Fr
RN8703	7" (178mm)	3 Fr
RN8704	7" (178mm)	4 Fr
RN8705	7" (178mm)	5 Fr
RN8706	7" (178mm)	6 Fr
RN8707	7" (178mm)	7 Fr
RN8708	7" (178mm)	8 Fr
RN8709	7" (178mm)	9 Fr
RN8710	7" (178mm)	10 Fr
RN8711	7" (178mm)	11 Fr
RN8712	7" (178mm)	12 Fr

Angled

Catalog#	Working Length	Diameter
RN8523	4¼" (108mm)	3 Fr
RN8524	4¼" (108mm)	4 Fr
RN8525	4¼" (108mm)	5 Fr
RN8526	4¼" (108mm)	6 Fr
RN8527	4¼" (108mm)	7 Fr
RN8528	4¼" (108mm)	8 Fr
RN8529	4¼" (108mm)	9 Fr
RN85210	4¼" (108mm)	10 Fr
RN85211	4¼" (108mm)	11 Fr
RN85212	4¼" (108mm)	12 Fr
RN8723	5¾" (146mm)	3 Fr
RN8724	5¾" (146mm)	4 Fr
RN8725	5¾" (146mm)	5 Fr
RN8726	5¾" (146mm)	6 Fr
RN8727	5¾" (146mm)	7 Fr
RN8728	5¾" (146mm)	8 Fr
RN8729	5¾" (146mm)	9 Fr
RN87210	5¾" (146mm)	10 Fr
RN87211	5¾" (146mm)	11 Fr
RN87212	5¾" (146mm)	12 Fr



RN85812

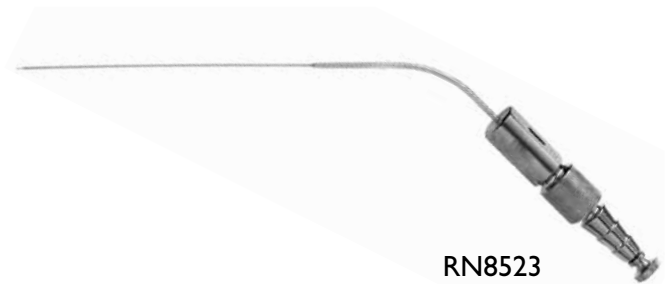

RN8523

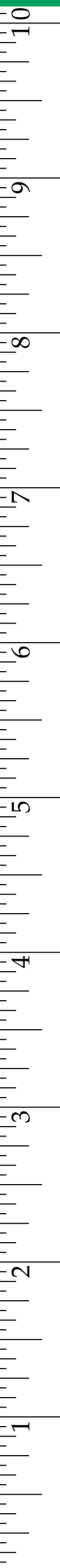

	○	○	○	○	○	○	○	○	○	○	○
French	3 Fr	4 Fr	5 Fr	6 Fr	7 Fr	8 Fr	9 Fr	10 Fr	11 Fr	12 Fr	15 Fr
Inches	.039	.053	.066	.079	.092	.105	.118	.131	.144	.158	.197
Millimeters	1	1.35	1.67	2.0	2.3	2.7	3.0	3.3	3.7	4.0	5.0

Frazier Suction Tubes

Malleable with Hole

Angled

Catalog#	Working Length	Diameter
R0708	4 ¹ / ₈ " (105mm)	3 Fr
R0707	4 ¹ / ₈ " (105mm)	5 Fr
R0710	4 ¹ / ₈ " (105mm)	6 Fr
R0711	4 ¹ / ₈ " (105mm)	7 Fr
R0712	4 ¹ / ₈ " (105mm)	8 Fr
R0713	4 ¹ / ₈ " (105mm)	9 Fr
R0714	4 ¹ / ₈ " (105mm)	10 Fr
R0715	4 ¹ / ₈ " (105mm)	11 Fr
R0716	4 ¹ / ₈ " (105mm)	12 Fr
R0778	5 ³ / ₄ " (146mm)	3 Fr
R0777	5 ³ / ₄ " (146mm)	5 Fr
R0770	5 ³ / ₄ " (146mm)	6 Fr
R0771	5 ³ / ₄ " (146mm)	7 Fr
R0772	5 ³ / ₄ " (146mm)	8 Fr
R0773	5 ³ / ₄ " (146mm)	9 Fr
R0774	5 ³ / ₄ " (146mm)	10 Fr
R0775	5 ³ / ₄ " (146mm)	11 Fr
R0776	5 ³ / ₄ " (146mm)	12 Fr

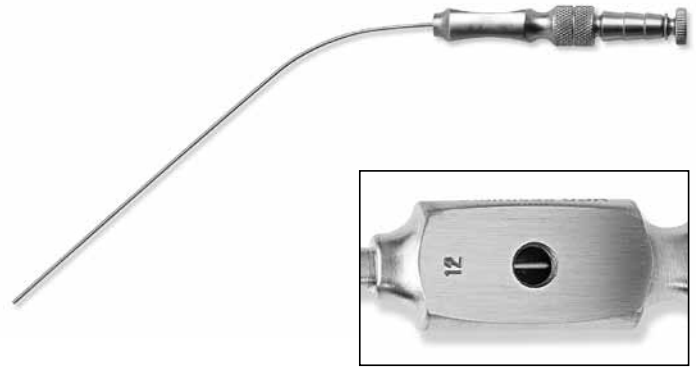

R0708



	○	○	○	○	○	○	○	○	○	○	○
French	3 Fr	4 Fr	5 Fr	6 Fr	7 Fr	8 Fr	9 Fr	10 Fr	11 Fr	12 Fr	15 Fr
Inches	.039	.053	.066	.079	.092	.105	.118	.131	.144	.158	.197
Millimeters	1	1.35	1.67	2.0	2.3	2.7	3.0	3.3	3.7	4.0	5.0

Poppen Suction Tubes

Malleable with Slot

Angled

Catalog#	Working Length	Diameter
R0658	3 ³ / ₄ " (95mm)	6 Fr
R0659	3 ³ / ₄ " (95mm)	7 Fr
R0660	3 ³ / ₄ " (95mm)	8 Fr
R0661	3 ³ / ₄ " (95mm)	9 Fr
R0662	3 ³ / ₄ " (95mm)	10 Fr
R0663	3 ³ / ₄ " (95mm)	11 Fr
R0664	3 ³ / ₄ " (95mm)	12 Fr
R0785	5 ³ / ₄ " (146mm)	6 Fr
R0786	5 ³ / ₄ " (146mm)	7 Fr
R0787	5 ³ / ₄ " (146mm)	8 Fr
R0788	5 ³ / ₄ " (146mm)	9 Fr
R0789	5 ³ / ₄ " (146mm)	10 Fr
R0790	5 ³ / ₄ " (146mm)	11 Fr
R0791	5 ³ / ₄ " (146mm)	12 Fr

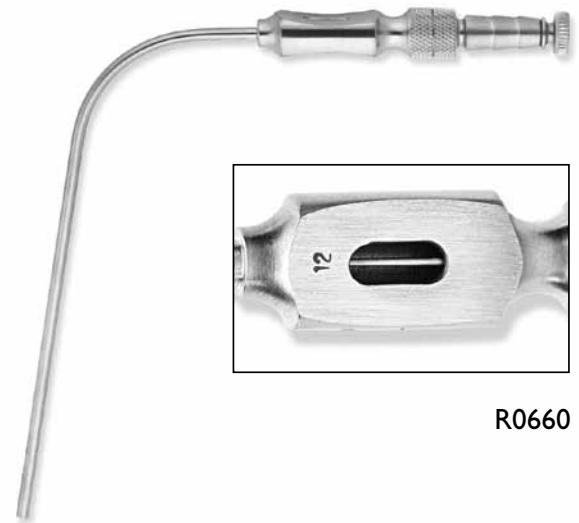

R0660

Adson Suction Tubes

Curved

Catalog#	Working Length	Hub Length	Diameter
RN8612	5/8" (16mm)	3/4" (83mm)	12 Fr
RN8615	3/4" (19mm)	5/4" (133mm)	15 Fr



RN8612

	○	○	○	○	○	○	○	○	○	○	○
French	3 Fr	4 Fr	5 Fr	6 Fr	7 Fr	8 Fr	9 Fr	10 Fr	11 Fr	12 Fr	15 Fr
Inches	.039	.053	.066	.079	.092	.105	.118	.131	.144	.158	.197
Millimeters	1	1.35	1.67	2.0	2.3	2.7	3.0	3.3	3.7	4.0	5.0

Atraumatic Tip Suction Tubes with Multiple Holes

Malleable

Angled

Catalog#	Working Length	Diameter
R0674	5 1/8" (135mm)	3 Fr
R0675	5 1/8" (135mm)	5 Fr
R0676	5 1/8" (135mm)	6 Fr
R0677	5 1/8" (135mm)	7 Fr
R0678	5 1/8" (135mm)	8 Fr
R0679	5 1/8" (135mm)	9 Fr
R0680	5 1/8" (135mm)	10 Fr
R0681	5 1/8" (135mm)	11 Fr
R0682	5 1/8" (135mm)	12 Fr

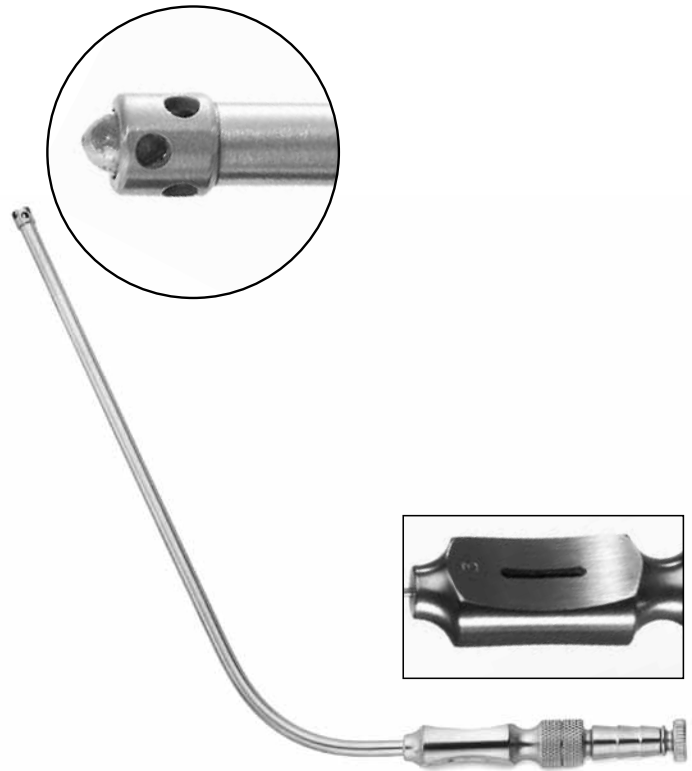

R0681

Multi-Hole Suction Tubes

5 Holes at Tip

Angled

Catalog#	Working Length	Diameter
RN9625	4 1/2" (114mm)	5 Fr
RN9627	4 1/2" (114mm)	7 Fr
RN9725	6 1/2" (165mm)	5 Fr
RN9727	6 1/2" (165mm)	7 Fr

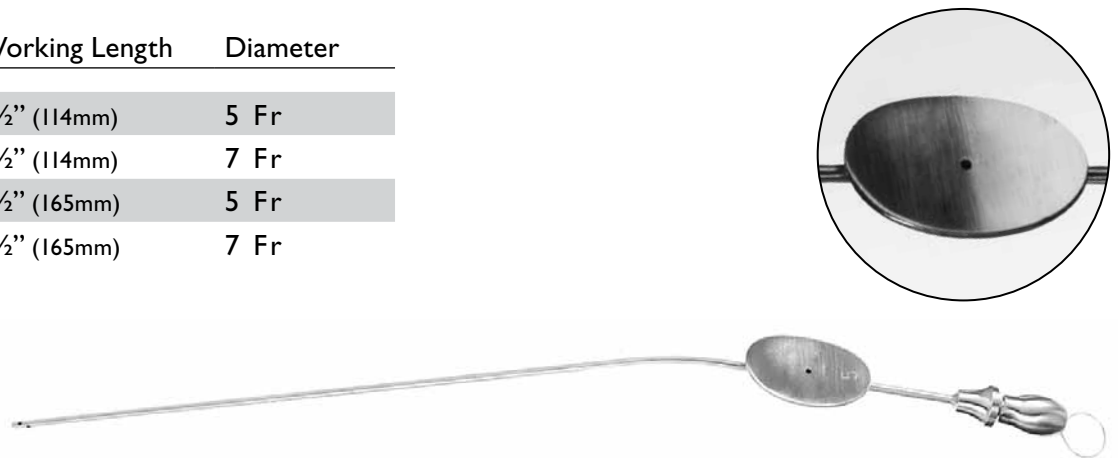

	○	○	○	○	○	○	○	○	○	○	○
French	3 Fr	4 Fr	5 Fr	6 Fr	7 Fr	8 Fr	9 Fr	10 Fr	11 Fr	12 Fr	15 Fr
Inches	.039	.053	.066	.079	.092	.105	.118	.131	.144	.158	.197
Millimeters	1	1.35	1.67	2.0	2.3	2.7	3.0	3.3	3.7	4.0	5.0

Atraumatic Tip Suction Tubes

Angled

Catalog#	Working Length	Diameter
RN9103	3 1/8" (79mm)	3 Fr
RN9105	3 1/8" (79mm)	5 Fr
RN9107	3 1/8" (79mm)	7 Fr
RN9110	3 1/8" (79mm)	10 Fr
RN9112	3 1/8" (79mm)	12 Fr
RN9203	4" (102mm)	3 Fr
RN9205	4" (102mm)	5 Fr
RN9207	4" (102mm)	7 Fr
RN9210	4" (102mm)	10 Fr
RN9212	4" (102mm)	12 Fr
RN9303	4 3/4" (121mm)	3 Fr
RN9305	4 3/4" (121mm)	5 Fr
RN9307	4 3/4" (121mm)	7 Fr
RN9310	4 3/4" (121mm)	10 Fr
RN9312	4 3/4" (121mm)	12 Fr



RN9307

Atraumatic Tip Suction Tubes

Curved Down

Catalog#	Working Length	Diameter
RN9505	5 1/2" (140mm)	5 Fr
RN9507	5 1/2" (140mm)	7 Fr
RN9510	5 1/2" (140mm)	10 Fr



RN9507

Curved Up

Catalog#	Working Length	Diameter
RN9405	5 1/2" (140mm)	5 Fr
RN9407	5 1/2" (140mm)	7 Fr
RN9410	5 1/2" (140mm)	10 Fr



RN9407



	○	○	○	○	○	○	○	○	○	○	○
French	3 Fr	4 Fr	5 Fr	6 Fr	7 Fr	8 Fr	9 Fr	10 Fr	11 Fr	12 Fr	15 Fr
Inches	.039	.053	.066	.079	.092	.105	.118	.131	.144	.158	.197
Millimeters	1	1.35	1.67	2.0	2.3	2.7	3.0	3.3	3.7	4.0	5.0

Endonasal Suction Tubes

- Teardrop-shaped control slot allows for extremely precise regulation of suction
- Four different pre-set curves permit suctioning of entire site
- Malleable shaft gives the surgeon additional flexibility to adjust the configuration of the suction tube as necessary, allowing access in cases where difficult patient anatomy or tumor location may be impossible for standard suction tubes to reach

Endonasal Suction Tubes

Catalog#	Description	Working Length	Diameter
RN82325	Short Curve Up	4 ³ / ₄ " (121mm)	5 Fr
RN82327	Short Curve Up	4 ³ / ₄ " (121mm)	7 Fr
RN82425	Long Curve Up	4 ³ / ₄ " (121mm)	5 Fr
RN82427	Long Curve Up	4 ³ / ₄ " (121mm)	7 Fr
RN82525	Straight	4 ³ / ₄ " (121mm)	5 Fr
RN82527	Straight	4 ³ / ₄ " (121mm)	7 Fr
RN825211	Straight	4 ³ / ₄ " (121mm)	11 Fr
RN82625	Short Curve Down	4 ³ / ₄ " (121mm)	5 Fr
RN82627	Short Curve Down	4 ³ / ₄ " (121mm)	7 Fr
RN82725	Long Curve Down	4 ³ / ₄ " (121mm)	5 Fr
RN82727	Long Curve Down	4 ³ / ₄ " (121mm)	7 Fr

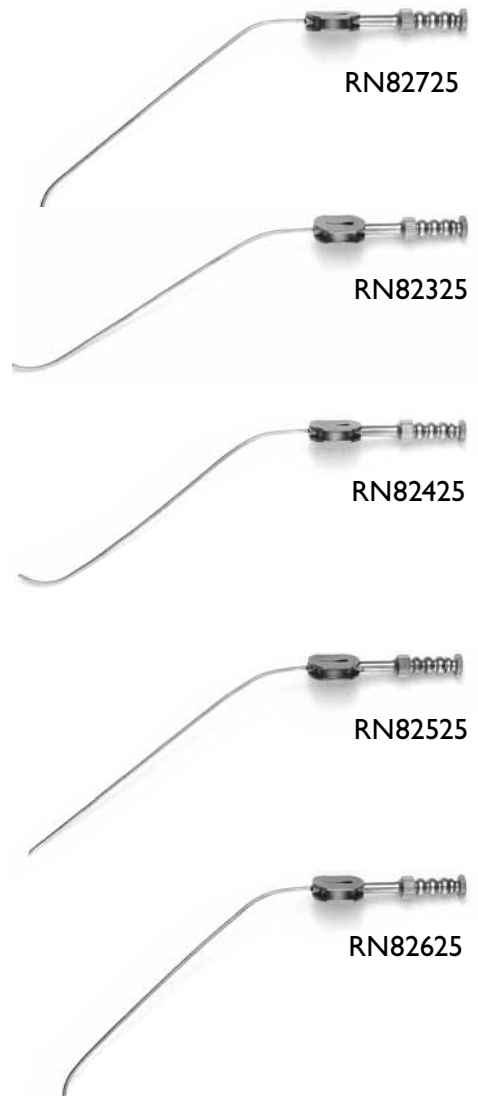

	○	○	○	○	○	○	○	○	○	○	○
French	3 Fr	4 Fr	5 Fr	6 Fr	7 Fr	8 Fr	9 Fr	10 Fr	11 Fr	12 Fr	15 Fr
Inches	.039	.053	.066	.079	.092	.105	.118	.131	.144	.158	.197
Millimeters	1	1.35	1.67	2.0	2.3	2.7	3.0	3.3	3.7	4.0	5.0

Bayonet Suction Tubes

Left Finger Control

Catalog#	Working Length	Hub Length	Overall Length	Diameter
RN9001L	3 ³ / ₈ " (86mm)	5" (127mm)	9" (229mm)	5 Fr
RN9002L	3 ³ / ₈ " (86mm)	5" (127mm)	9" (229mm)	7 Fr
RN9003L	3 ³ / ₈ " (86mm)	5" (127mm)	9" (229mm)	9 Fr

RN9000L Set of 3 Bayonet Suction Tubes



RN9001L

Right Finger Control

Catalog#	Working Length	Diameter
RN9001R	3 ³ / ₈ " (86mm)	5 Fr
RN9002R	3 ³ / ₈ " (86mm)	7 Fr
RN9003R	3 ³ / ₈ " (86mm)	9 Fr

RN9000R Set of 3 Bayonet Suction Tubes



RN9001R

Top Finger Control

Catalog#	Working Length	Diameter
RN9001T	3 ³ / ₈ " (86mm)	5 Fr
RN9002T	3 ³ / ₈ " (86mm)	7 Fr
RN9003T	3 ³ / ₈ " (86mm)	9 Fr

RN9000T Set of 3 Bayonet Suction Tubes



RN9003T

For Black Chrome Bayonet Suction Tubes, change RN prefix to RA

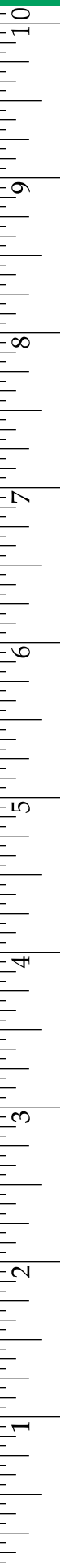

	○	○	○	○	○	○	○	○	○	○	○
French	3 Fr	4 Fr	5 Fr	6 Fr	7 Fr	8 Fr	9 Fr	10 Fr	11 Fr	12 Fr	15 Fr
Inches	.039	.053	.066	.079	.092	.105	.118	.131	.144	.158	.197
Millimeters	1	1.35	1.67	2.0	2.3	2.7	3.0	3.3	3.7	4.0	5.0

Tapered Teardrop Suction Tubes Semi-Rigid

Catalog#	Working Length	Diameter
RN8253	5 ¼" (133mm)	3 Fr
RN8254	5 ¼" (133mm)	4 Fr
RN8255	5 ¼" (133mm)	5 Fr
RN8256	5 ¼" (133mm)	6 Fr
RN8257	5 ¼" (133mm)	7 Fr
RN8258	5 ¼" (133mm)	8 Fr
RN8259	5 ¼" (133mm)	9 Fr
RN82510	5 ¼" (133mm)	10 Fr
RN82512	5 ¼" (133mm)	12 Fr
RN8263	6 ¼" (159mm)	3 Fr
RN8264	6 ¼" (159mm)	4 Fr
RN8265	6 ¼" (159mm)	5 Fr
RN8266	6 ¼" (159mm)	6 Fr
RN8267	6 ¼" (159mm)	7 Fr
RN8268	6 ¼" (159mm)	8 Fr
RN8269	6 ¼" (159mm)	9 Fr
RN82610	6 ¼" (159mm)	10 Fr
RN82612	6 ¼" (159mm)	12 Fr
RN8283	7" (178mm)	3 Fr
RN8284	7" (178mm)	4 Fr
RN8285	7" (178mm)	5 Fr
RN8286	7" (178mm)	6 Fr
RN8287	7" (178mm)	7 Fr
RN8288	7" (178mm)	8 Fr
RN8289	7" (178mm)	9 Fr
RN82810	7" (178mm)	10 Fr
RN82812	7" (178mm)	12 Fr



RN8264



	○	○	○	○	○	○	○	○	○	○	○
French	3 Fr	4 Fr	5 Fr	6 Fr	7 Fr	8 Fr	9 Fr	10 Fr	11 Fr	12 Fr	15 Fr
Inches	.039	.053	.066	.079	.092	.105	.118	.131	.144	.158	.197
Millimeters	1	1.35	1.67	2.0	2.3	2.7	3.0	3.3	3.7	4.0	5.0

T. Fukushima Tapered Teardrop Suction Tubes
Malleable

Catalog#	Working Length	Diameter
R9007	3¼" (83mm)	2 Fr
R9000	3¼" (83mm)	3 Fr
R8980	3¼" (83mm)	4 Fr
R8981	3¼" (83mm)	5 Fr
R8982	3¼" (83mm)	6 Fr
R8983	3¼" (83mm)	7 Fr
R8984	3¼" (83mm)	8 Fr
R8985	3¼" (83mm)	9 Fr
R9042	3¼" (83mm)	10 Fr
RB8631	3¼" (83mm)	11 Fr
R9043	3¼" (83mm)	12 Fr
R9008	4" (102mm)	2 Fr
R9001	4" (102mm)	3 Fr
R8986	4" (102mm)	4 Fr
R8987	4" (102mm)	5 Fr
R8988	4" (102mm)	6 Fr
R8989	4" (102mm)	7 Fr
R8990	4" (102mm)	8 Fr
R8991	4" (102mm)	9 Fr
R9044	4" (102mm)	10 Fr
RB8731	4" (102mm)	11 Fr
R9045	4" (102mm)	12 Fr

Catalog#	Working Length	Diameter
R9009	4¾" (121mm)	2 Fr
R9002	4¾" (121mm)	3 Fr
R8992	4¾" (121mm)	4 Fr
R8993	4¾" (121mm)	5 Fr
R8994	4¾" (121mm)	6 Fr
R8995	4¾" (121mm)	7 Fr
R8996	4¾" (121mm)	8 Fr
R8997	4¾" (121mm)	9 Fr
R9046	4¾" (121mm)	10 Fr
RB8831	4¾" (121mm)	11 Fr
R9047	4¾" (121mm)	12 Fr
R9010	5¾" (146mm)	2 Fr
R9003	5¾" (146mm)	3 Fr
R9004	5¾" (146mm)	4 Fr
R9005	5¾" (146mm)	5 Fr
R9006	5¾" (146mm)	6 Fr
R8965	5¾" (146mm)	7 Fr
R8966	5¾" (146mm)	8 Fr
R8967	5¾" (146mm)	9 Fr
R8968	5¾" (146mm)	10 Fr
R8969	5¾" (146mm)	11 Fr



R8966

	○	○	○	○	○	○	○	○	○	○	○
French	3 Fr	4 Fr	5 Fr	6 Fr	7 Fr	8 Fr	9 Fr	10 Fr	11 Fr	12 Fr	15 Fr
Inches	.039	.053	.066	.079	.092	.105	.118	.131	.144	.158	.197
Millimeters	1	1.35	1.67	2.0	2.3	2.7	3.0	3.3	3.7	4.0	5.0

Tapered Teardrop Suction Tubes Super Malleable, Stainless Steel

Catalog#	Working Length	Diameter	Catalog#	Working Length	Diameter
R9012SM	5¾" (146mm)	2 Fr	R9008SM	7" (178mm)	2 Fr
R9013SM	5¾" (146mm)	3 Fr	R9001SM	7" (178mm)	3 Fr
R9014SM	5¾" (146mm)	4 Fr	R8986SM	7" (178mm)	4 Fr
R9015SM	5¾" (146mm)	5 Fr	R8987SM	7" (178mm)	5 Fr
R9016SM	5¾" (146mm)	6 Fr	R8988SM	7" (178mm)	6 Fr
R9017SM	5¾" (146mm)	7 Fr	R8989SM	7" (178mm)	7 Fr
R9018SM	5¾" (146mm)	8 Fr	R8990SM	7" (178mm)	8 Fr
R9019SM	5¾" (146mm)	9 Fr	R8991SM	7" (178mm)	9 Fr
R9020SM	5¾" (146mm)	10 Fr	R9044SM	7" (178mm)	10 Fr
R9021SM	5¾" (146mm)	12 Fr	R9045SM	7" (178mm)	12 Fr
R9007SM	6½" (165mm)	2 Fr	R9009SM	8" (203mm)	2 Fr
R9000SM	6½" (165mm)	3 Fr	R9002SM	8" (203mm)	3 Fr
R8980SM	6½" (165mm)	4 Fr	R8992SM	8" (203mm)	4 Fr
R8981SM	6½" (165mm)	5 Fr	R8993SM	8" (203mm)	5 Fr
R8982SM	6½" (165mm)	6 Fr	R8994SM	8" (203mm)	6 Fr
R8983SM	6½" (165mm)	7 Fr	R8995SM	8" (203mm)	7 Fr
R8984SM	6½" (165mm)	8 Fr	R8996SM	8" (203mm)	8 Fr
R8985SM	6½" (165mm)	9 Fr	R8997SM	8" (203mm)	9 Fr
R9042SM	6½" (165mm)	10 Fr	R9046SM	8" (203mm)	10 Fr
R9043SM	6½" (165mm)	12 Fr	R9047SM	8" (203mm)	12 Fr



R9008SM



MICROSURGICAL INSTRUMENTATION



Micro Dissection Set

Catalog#

RN6200

Set includes one each of items RN6201 through RN6215 (see next page) and one Instrument Tray RN6220

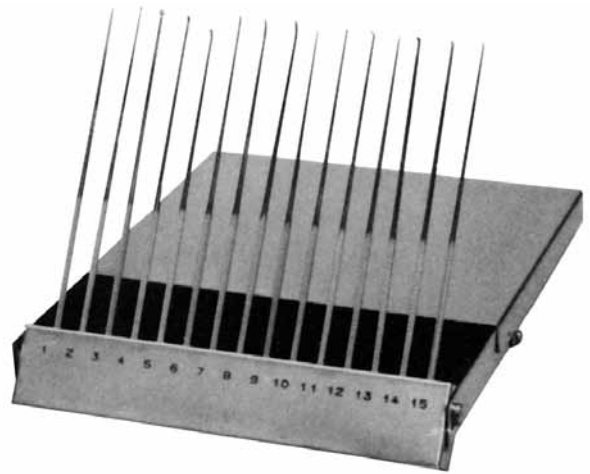

RN6200

Expanded Micro Dissection Set

Catalog#

RN6230

Set includes one each of items RN6201 through RN6219 (see next page) and one Instrument Tray RS6219



RN6230

Dissection Set catalog numbers are listed on the previous page.

Micro Dissection Set Components

7½" (191mm) Length

Round Dissector

Catalog#	Tip Diameter
RN6201	1mm
RN6202	2mm
RN6203	3mm

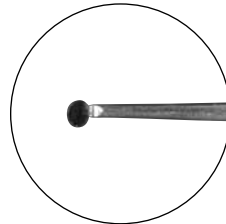

RN6201

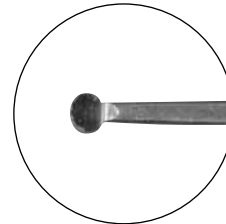

RN6202

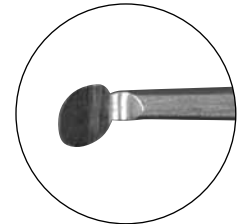

RN6203

Elevator

Catalog#	Tips	Tip Width
RN6204	Curved	2.5mm
RN6205	Angled	1mm

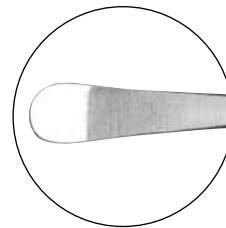

RN6204

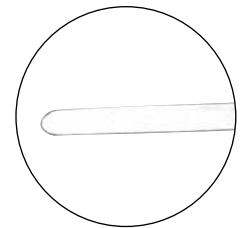

RN6205

Spatula Dissector

Catalog#	Tips	Tip Width
RN6206	Small	1mm
RN6207	Medium	1.5mm
RN6208	Large	2mm

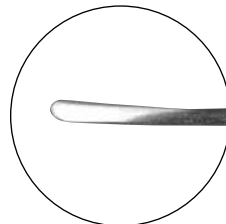

RN6206

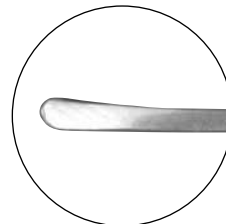

RN6207

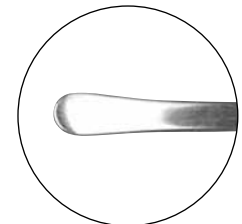

RN6208

Right Angle Hook

Catalog#	Tips	Hook Length
RN6209	Semi-Sharp	2mm
RN6210	Blunt	3mm

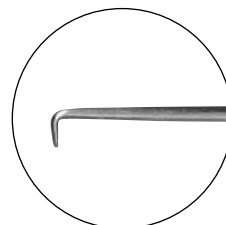

RN6209

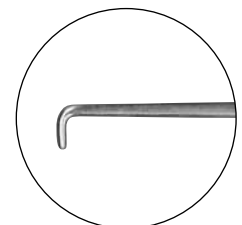

RN6210

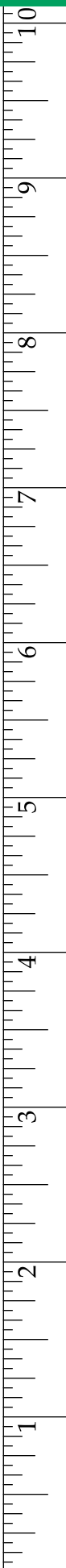

Micro Dissection Set Components, continued

7½" (191mm) Length

Needle Dissector

Catalog#	Tips	Tip Length
RN6211	Semi-Sharp, 45° Angle	3mm
RN6212	Semi-Sharp, Straight	

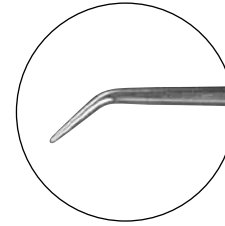

RN6211

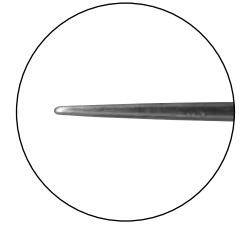

RN6212

Micro Curette

Catalog#	Tips
RN6213	1 × 2mm Cup, Straight
RN6214	1 × 2mm Cup, Angled

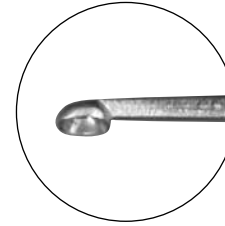

RN6213

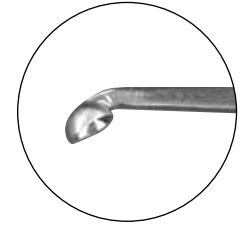

RN6214

Ball Dissector

Catalog#	Tips	Tip Length
RN6215	90° Angle	3mm
RN6216	90° Angle	5mm
RN6217	45° Angle	4mm
RN6218	45° Angle	8mm
RN6219	Straight	

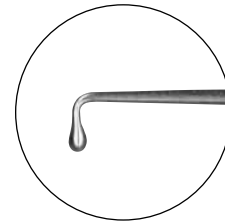

RN6215

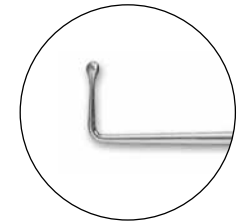

RN6216

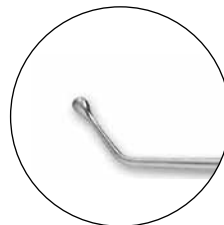

RN6217

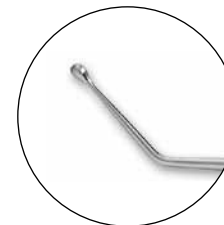

RN6218

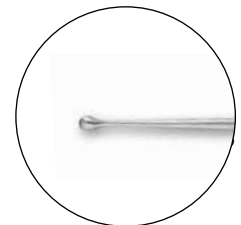

RN6219

Micro Dissection Instrument Tray

Catalog#
RN6220



RN6220

Expanded Micro Dissection Instrument Tray

Catalog#
RS6219



RS6219



Apfelbaum Dissector Set
Straight, 8¾" (222mm) Length

Catalog# _____

RN6700 Set includes one each of items RN6701 through RN6717 and one Instrument Tray RS6700



Round Dissector

Catalog#	Tips	Tip Diameter
RN6701	Sharp Edges	1mm
RN6702	Sharp Edges	2mm
RN6703	Sharp Edges	3mm

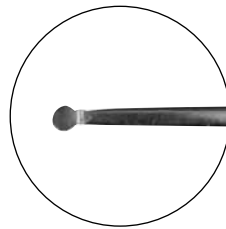

RN6701

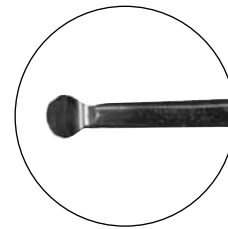

RN6702

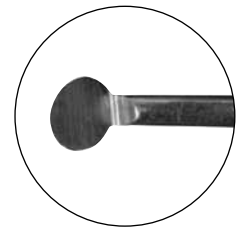

RN6703

Elevator

Catalog#	Tips	Tips Width
RN6704	Wide	2.5mm
RN6705	Narrow	2mm

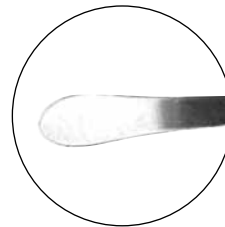

RN6704

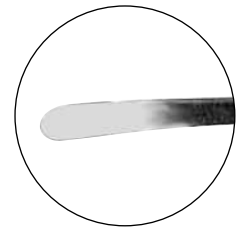

RN6705

Spatula Dissector

Catalog#	Tips
RN6706	Curved
RN6707	Angled
RN6708	90°

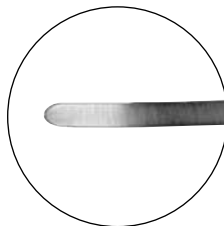

RN6706

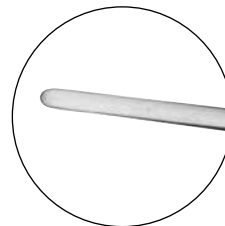

RN6707

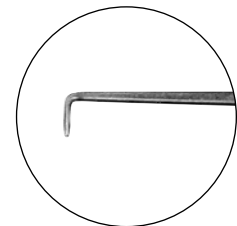

RN6708



Apfelbaum Dissector Set, continued
Straight, 8¾" (222mm) Length

Right Angle Hook

Catalog#	Tips
RN6709	45°

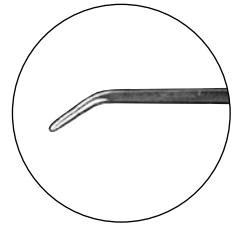

RN6709

Teardrop Dissector

Catalog#	Tips
RN6710	90°
RN6711	45°

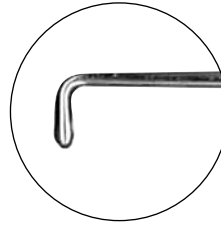

RN6710

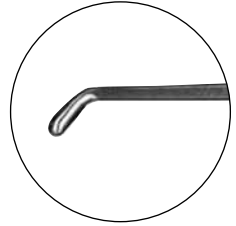

RN6711

Dura Knife

Catalog#	Tips
RN6712	Large
RN6713	Small

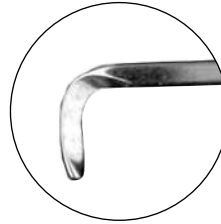

RN6712



RN6713

Curette

Catalog#	Tips	Cup Size
RN6714	Angled	1mm
RN6715	Angled	2mm
RN6716	Double Angled	1mm
RN6717	Double Angled	2mm

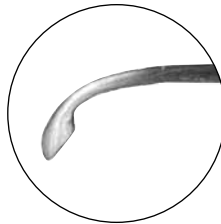

RN6714

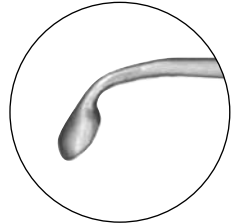

RN6715

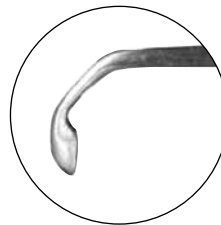

RN6716

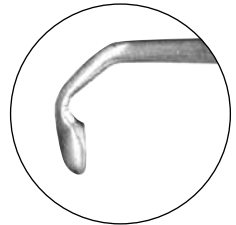

RN6717

Apfelbaum Dissection Tray

Catalog#	Description
RS6700	Straight Holds RN6701 through RN6717



RS6700



Apfelbaum Dissector Set

Angled, 8³/₄" (222mm) Length

Catalog#

RN6600 Set includes one each of items RN6601 through RN6617 and one Instrument Tray RS6600



Round Dissector

Catalog#	Tips	Tip Diameter
RN6601	Sharp Edges	1mm
RN6602	Sharp Edges	2mm
RN6603	Sharp Edges	3mm

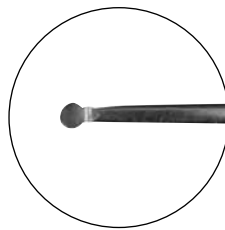

RN6601

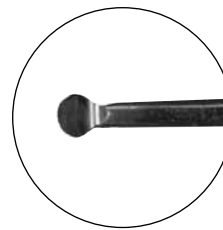

RN6602

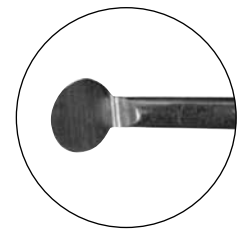

RN6603

Elevator

Catalog#	Tips	Tip Width
RN6604	Wide	2.5mm
RN6605	Narrow	2mm

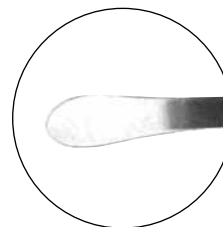

RN6604

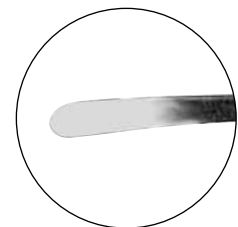

RN6605

Spatula Dissector

Catalog#	Tips
RN6606	Curved
RN6607	Angled
RN6608	90°

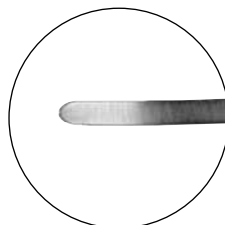

RN6606

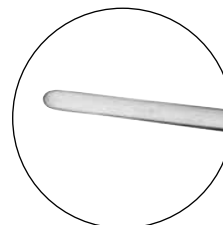

RN6607

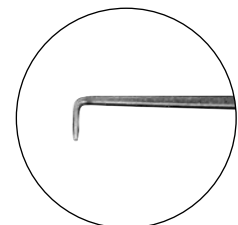

RN6608

Apfelbaum Dissector Set, continued
Angled, 8³/₄" (222mm) Length

Right Angle Hook

Catalog#	Tips
RN6609	45°

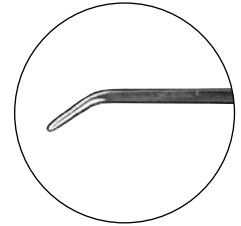

RN6609

Teardrop Dissector

Catalog#	Tips
RN6610	90°
RN6611	45°

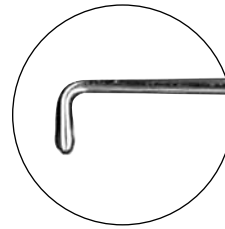

RN6610



RN6611

Dura Knife

Catalog#	Tips
RN6612	Large
RN6613	Small

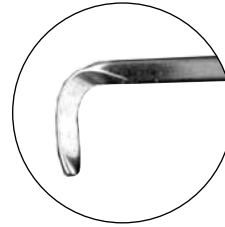

RN6612



RN6613

Curette

Catalog#	Tips	Cup Size
RN6614	Angled	1mm
RN6615	Angled	2mm
RN6616	Double Angled	1mm
RN6617	Double Angled	2mm



RN6714

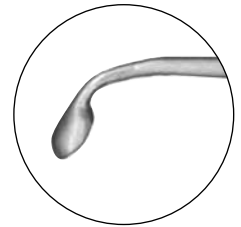

RN6715

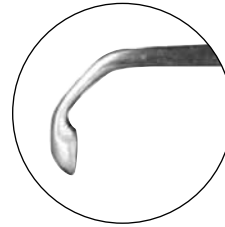

RN6716



RN6717

Apfelbaum Dissection Tray (not shown)

Catalog#	Description
RS6600	Angled Holds RN6601 through RN6617



Apfelbaum Micro Dissection Mirror

Catalog#	Length	Tip Diameter
RN6626	9" (229mm)	6mm



RN6626

Micro Dissection Set

Straight, 7¼" (184mm) Length

Ligature Guide

Catalog#	Tips	Tip Diameter
R8401	Slight Curve	1.5mm
R8402	Strong Curve	1.5mm
R8403	Angled	1.5mm



R8401



R8402

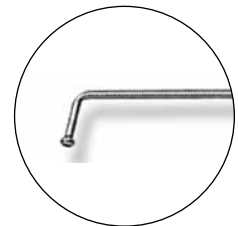

R8403

Jacobson Vessel Knife

Catalog#	Tips
R8408	Straight

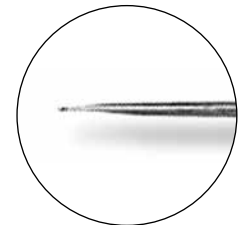

R8408

Raspatory

Catalog#	Tips	Tip Length
R8409	Angled	8mm

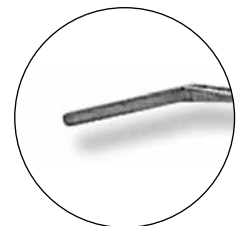

R8409

Dissector

Catalog#	Tip Length
R8410	9mm

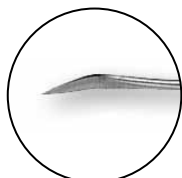

R8410



Micro Dissection Set, continued
Straight, 7/4" (184mm) Length

Raspatory

Catalog#	Tips
R8411	Large
R8412	Small
R8413	Strong Curve

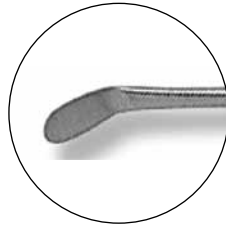

R8411

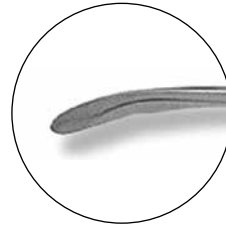

R8412

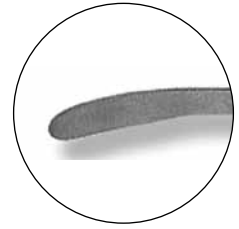

R8413

Jacobson Probe

Catalog#	Tips
R8414	Angled, Ball Tip
R8415	Straight, Double Ball Tip

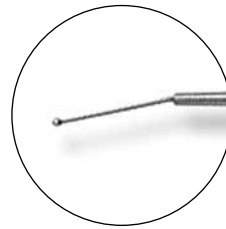

R8414

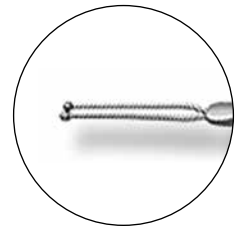

R8415

Jacobson Suture Pusher

Catalog#
R8416

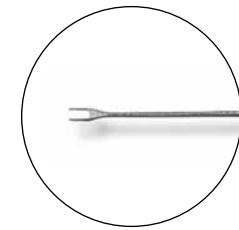

R8416

F-G Fukushima-Giannotta Skullbase and Micro Dissectors

7¼" (184mm) Length

Catalog#	Description
R8977	Holds R8935 through R8958

Dissector

Catalog#	Tips	Tips
R8935	Slightly Curved	3mm
R8936	Very Curved	2.5mm
R8937	Duckbill Curved	2.5mm
R8938	Slightly Curved	2mm
R8939	Very Curved	2mm

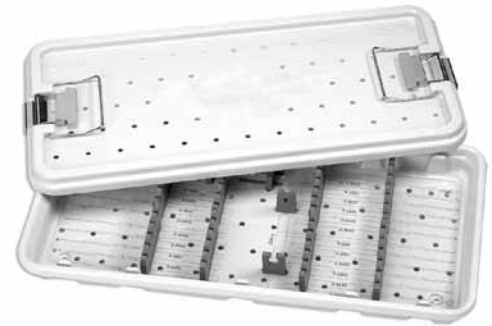

R8977



R8935



R8935



R8936

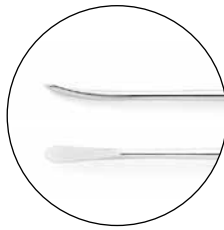

R8937

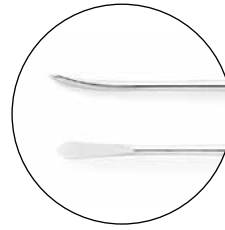

R8938

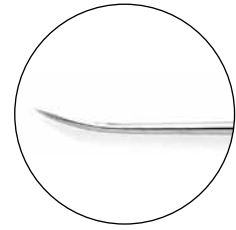

R8939

Knife

Catalog#	Tips	Tip Width
R8940	Round Angle	2mm

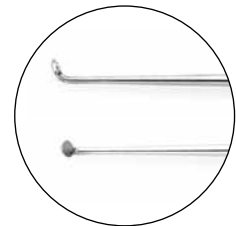

R8940

Hook

Catalog#	Tips	Tip Length
R8941	90° Straight	2.5mm

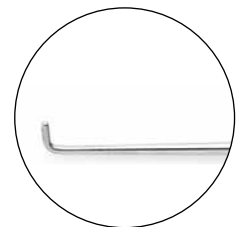

R8941

F-G Fukushima-Giannotta Skullbase and Micro Dissectors, continued

7/4" (184mm) Length

Knife (not shown)

Catalog#	Tips	Tip Length
R8942	90° Sharp Tip	3mm
R8943	90° Blunt Tip	4mm
R8944	45° Sharp Tip	3mm

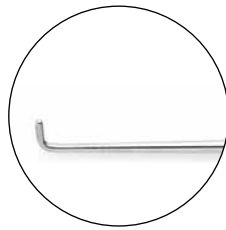

R8942

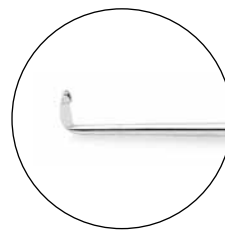

R8943

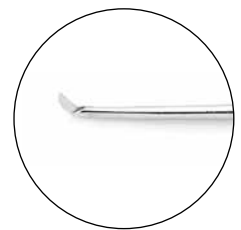

R8944

Probe

Catalog#	Tips
R8945	Straight Bullet Tip

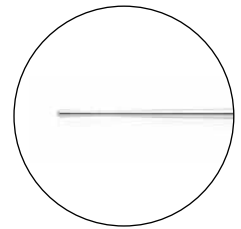

R8945

Separator

Catalog#	Tips	Tip Length
R8954	Slight Curve	4mm
R8955	90°	4mm



R8954



R8955

F-G Fukushima-Giannotta Skullbase and Micro Dissectors, continued

7/4" (184mm) Length

Tray

Catalog#	Description
R8977	Holds R8935 through R8958

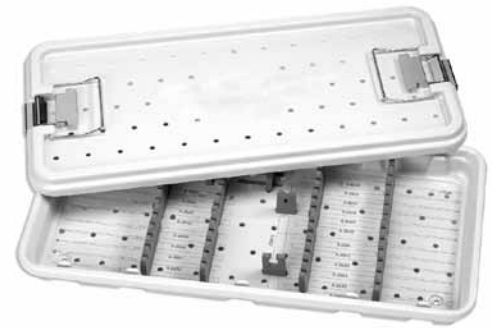

R8977

Bayonet Probe

Catalog#	Tips	Tip Length
R8946	Straight, Bullet Tip	
R8947	30° Bullet Tip	3mm
R8948	60° Bullet Tip	3mm
R8949	90° Bullet Tip	3mm



R8946

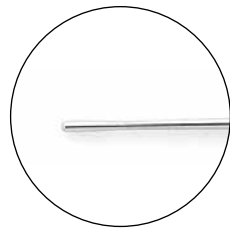

R8946

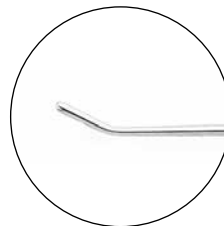

R8947

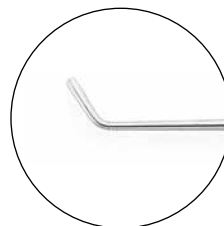

R8948

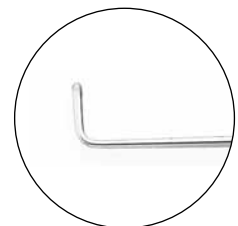

R8949

Ring Curette

Catalog#	Tips	Ring Size
R8950	2.5mm, 45° Up, Sharp	2.5mm
R8951	3mm, 45° Up, Sharp	3mm
R8952	4mm, 45° Up, Sharp	4mm

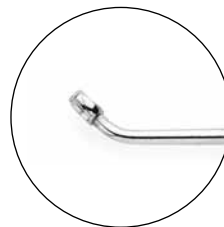

R8950

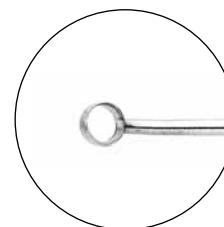

R8951



R8952

Cup Curette

Catalog#	Tips	Cup Size
R8953	20° Up	2 × 3 mm



R8953

F-G Fukushima-Giannotta Skullbase and Micro Dissectors, continued

7/4" (184mm) Length

Dissector, Insulated

Catalog#	Description	Tip Width
R8956	Touch Spring for Electrocautery	3mm



R8956

Probe, Insulated

Catalog#	Description
R8958	Touch Spring for Electrocautery



R8958



F-G Fukushima-Chen Cerebellar Pontine Tumor Bayonet Micro Dissectors

7½" (191mm) Length



Knife

Catalog#	Tips	Tip Length
R8876	Very Sharp, Blunt Tip	
R8877	45° Up, Semi-Blunt	2.5mm
R8878	45° Up, Sharp	3mm
R8879	80° Up, Sharp Tip and Edge	2.5mm
R8881	Sickle Style, Very Thin, Sharp	

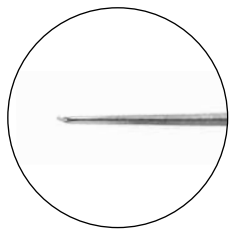

R8876

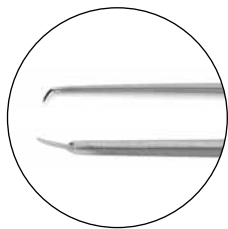

R8877

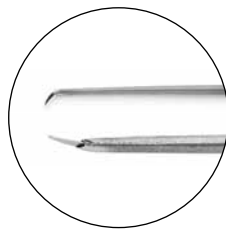

R8878

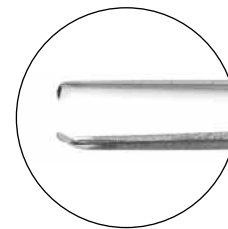

R8879

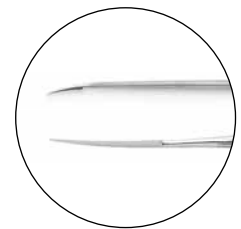

R8881

Round Knife

Catalog#	Tips	Tip Diameter
R8887	Angled, Very Sharp	1mm
R8888	Angled, Very Sharp	1.5mm

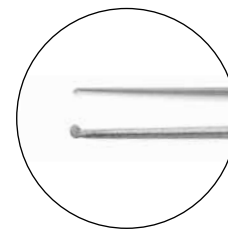

R8887

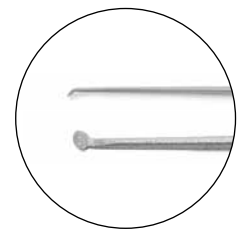

R8888

Probe

Catalog#	Tips	Tip Length
R8880	90° Up, Bullet Tip	3mm

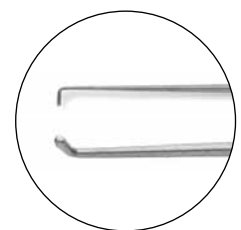

R8880

F-G Fukushima-Chen Cerebellar Pontine Tumor Bayonet Micro Dissectors, continued
7½" (191mm) Length

Ring Curette

Catalog#	Tips	Ring Diameter
R8882	60° Up	1.2mm
R8883	45° Up	1.5mm
R8884	45° Up	2mm

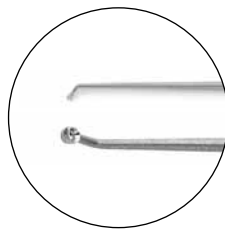

R8882

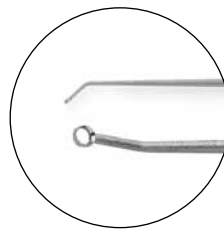

R8883

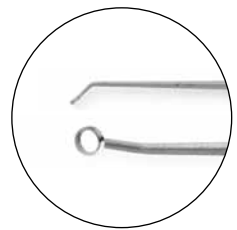

R8884

Cup Curette

Catalog#	Tips	Cup Size
R8885	Angled	1 × 1.5mm
R8886	Straight	1.5 × 2mm

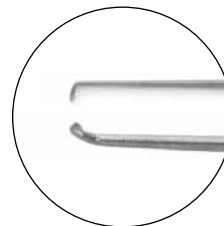

R8885

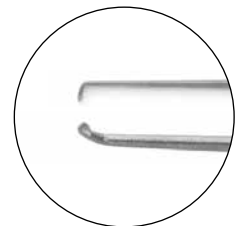

R8886

Dissector

Catalog#	Tips	Tip Width
R8889	45° Up, Sharp	2.5mm
R8890	45° Up, Sharp	3mm
R8891	45° Up, Sharp	4mm

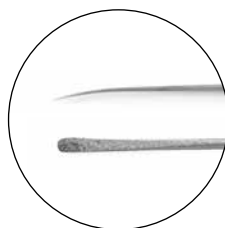

R8889

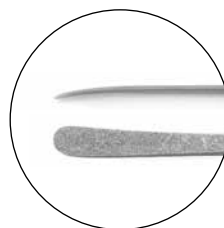

R8890

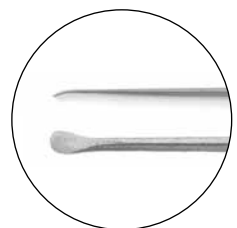

R8891



Round Handled Rhoton Style Instruments

7/2" (191mm) Length

Dissector

Catalog#	Tip Diameter
R7330	1mm
R7331	2mm
R7332	3mm



Elevator

Catalog#	Tip Width
R7333	2.6mm
R7334	1.2mm

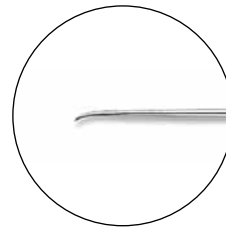

R7333

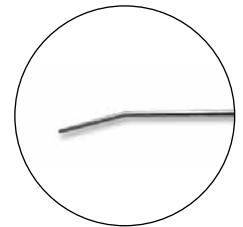

R7334

Spatula

Catalog#	Tip Width
R7335	1mm
R7336	1.5mm
R7337	2mm

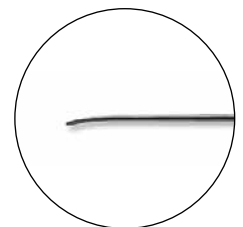

R7335



Round Handled Rhoton Style Instruments, continued
7½" (191mm) Length

Hook

Catalog#	Tips	Tip Length
R7338	90° Semi-Sharp	2mm
R7339	90° Blunt	3mm

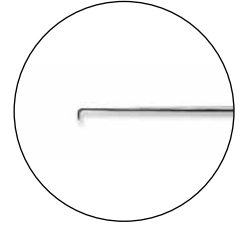
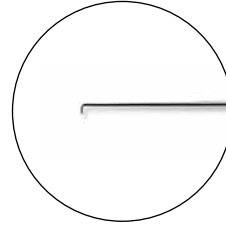

R7338

R7339

Probe

Catalog#	Tips	Tip Length
R7340	2mm, 90°, Ball Tip	3mm

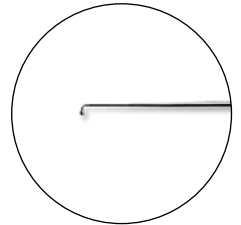

R7340

Hook

Catalog#	Tips	Tip Length
R7341	45° Semi-Sharp	3mm

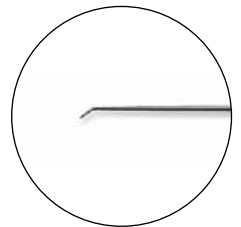

R7341

Needle

Catalog#	Tips
R7342	Semi-Sharp

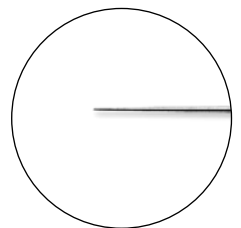

R7342

Oval Curette

Catalog#	Tips	Cup Size
R7343	Straight	1.5 × 2mm
R7344	Angled	1.5 × 2mm

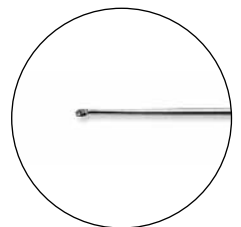

R7343

Yasargil Micro Dissector
Bayonet

Catalog#	Description	Length	Working Length	Tip Width
RB9344	Arachnoid Knife	7 1/4" (184mm)	2 1/4" (57mm)	3 mm
RB9345	Rasp, Slightly Curved	7 1/4" (184mm)	2 1/4" (57mm)	3 mm
RB9346	Rasp, Backward Cutting	7 1/4" (184mm)	2 1/4" (57mm)	3 mm
RB9347	Rasp, Forward Cutting	7 1/4" (184mm)	2 1/4" (57mm)	3 mm
RB9348	Curette	7 1/4" (184mm)	2 1/4" (57mm)	3 mm



Yasargil Micro Dissector
Straight

Catalog#	Description	Tip	Length	Tip Length	Tip Width
RB9339	Dissector, Round	Angled	7 1/4" (184mm)	6.5 mm	3 mm
RB9340	Rasp, Round	Slightly Curved	7 1/4" (184mm)		3 mm
RB9341	Rasp, Round	Strongly Curved	7 1/4" (184mm)		1 mm
RB9342	Rasp	Double Angled	7 1/4" (184mm)	8 mm	1.5 mm
RB9343	Dissector, Pointed	Double Angled	7 1/4" (184mm)	9 mm	3 mm



Titanium Dissection Instruments

Rhoton Style, 7" (178mm) Length

Ligature Passer

Catalog#	Tip Length
651301	3mm



651301

Nerve Hook

Catalog#	Tips	Tip Length
651302	with Ball	3mm
651303		2mm
651304		3mm

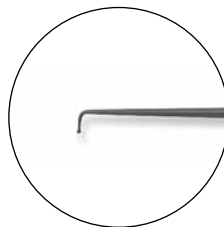

R7332

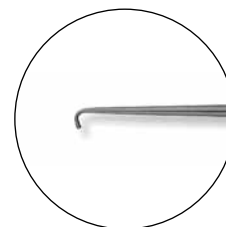

R7333

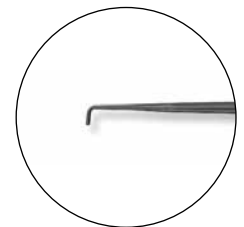

R7334

Vessel Supporter

Catalog#	Tip Width
651305	2mm

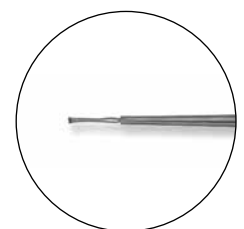

R7335



Titanium Dissection Instruments, continued

7" (178mm) Length

Dissector

Catalog#	Tips	Tip Length
651306	Angled, Curved Edge, Semi-Sharp	3.5mm



651306

Bayonet Curette

Catalog#	Cup Size
651307	2mm



651307

Elevator

Catalog#	Tips	Tip Width
651308	Curved	3.5mm
651309	Bayonet	3.5mm



651308

Dissector

Catalog#	Tips	Tip Width
651310	Angled, Sharp on 3 Sides	1mm



651310

Round Dissector

Catalog#	Tip Width
651311	1.0mm
651312	2.0mm
651313	3.5mm



651312



Titanium Biopsy Needle



651601

Catalog#

651600

Window	$\frac{3}{8}$ " (10mm)
Cannula Outer Length	$7\frac{7}{8}$ " (200mm)
Cannula Inner Length	$8\frac{5}{8}$ " (219mm)
Overall Cannula Length	$9\frac{3}{4}$ " (248mm)
Outer Diameter	$\frac{1}{8}$ " (3mm)
Inner Diameter	$\frac{5}{16}$ " (2mm)

Catalog#

651601

Window	$\frac{3}{16}$ " (5mm)
Cannula Outer Length	$7\frac{7}{8}$ " (200mm)
Cannula Inner Length	$8\frac{5}{8}$ " (219mm)
Overall Cannula Length	$9\frac{3}{4}$ " (248mm)
Outer Diameter	$\frac{1}{8}$ " (3mm)
Inner Diameter	$\frac{5}{16}$ " (2mm)

Catalog#

651605

Window	$\frac{3}{8}$ " (10mm)
Cannula Outer Length	$7\frac{9}{16}$ " (190mm)
Cannula Inner Length	$4\frac{5}{16}$ " (109mm)
Overall Cannula Length	$5\frac{7}{16}$ " (138mm)
Outer Diameter	$\frac{1}{8}$ " (3mm)
Inner Diameter	$\frac{5}{16}$ " (2mm)

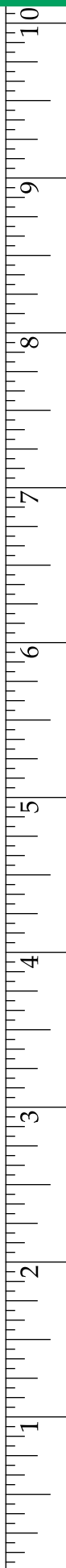

Krayenbuhl Hook with Finger Rest

Catalog#	Tip	Description	Length	Tip Length	Tip Diameter
RN8121	Blunt Hook	Small	7¼" (184mm)	2.5mm	
RN8122	Blunt Hook	Large	7¼" (184mm)	3.5mm	
RN8123	Ball Tip	Small	7¼" (184mm)	2.5mm	1mm
RN8124	Ball Tip	Large	7¼" (184mm)	3.5mm	1mm

Krayenbuhl Hook without Finger Rest

Catalog#	Tip	Description	Length	Tip Diameter
RN8125	Dura Hook	Curved	7¼" (184mm)	
RN8126	Dura Hook	90° Angle	7¼" (184mm)	
RN8127	Twist Hook	Straight	7¼" (184mm)	1mm
RN8128	Twist Hook	Straight	7¼" (184mm)	2mm



RN8126



RN8128

Cushing Ganglion Hook

Catalog#	Tip	Length
R0845	5mm	9" (230mm)



R0855



Weary Nerve Hook

Catalog#	Tip Length	Length	Description
RN0127	3mm	8" (203mm)	Black Finish (Ebony)



RN0127

Dura Hook

Catalog#	Length	Description
R8234	7/4" (184mm)	Regular
R8235	7/4" (184mm)	Delicate



R8234





Microsurgical Bayonet Handle Hook

9½" (240mm)

Nerve Hook

Catalog#	Tip	Tip Length
R7305	3mm, 90°	3mm
R7306	4mm, 90°	4mm
R7307	5mm, 90°	5mm
R7308	5mm, Curved Up	5mm
R7309	8mm, Curved Up	8mm
R7310	3mm, Ball Point	4mm

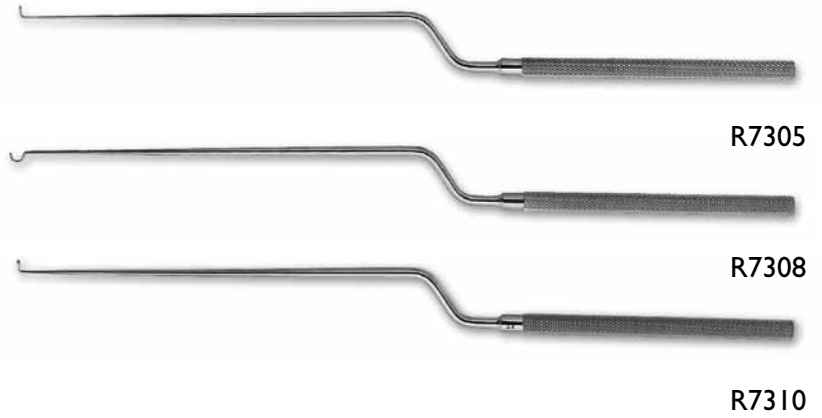

Micro Hook

Catalog#	Tip	Tip Length
R7315	Blunt	2mm
R7316	Blunt	2.5mm
R7317	Blunt	3mm
R7318	Semi-Sharp	2mm



Ligature Needle

Catalog#	Tip Length
R7320	3mm
R7321	5mm



Yasargil Ligature Carrier

7¼" (184mm) Length

Catalog#	Description	Blade	Length
RN8111	Probe Point	90° Angle	7½" (191mm)
RN8112	Probe Point	¾" (19mm), Curved	7½" (191mm)
RN8113	Probe Point Short	⅝" (16mm), Curved, Short	7½" (191mm)
RN8114	Probe Point Long	½" (13mm), Curved, Long	7½" (191mm)



RN8112

Micro Arachnoidea Knife

Catalog#	Blade	Length	Tip Length
R8445	Curved Down	7¼" (184mm)	3mm



R8445



Micro Forceps
Round Handle

Catalog#	Description	Teeth	Length
RN8294	Round Handle	1 × 2, Delicate	7" (178mm)



Micro Tying Forceps
Counterbalanced, Round Handle

RN8294

Catalog#	Description	Length
RN8295	Tungsten Carbide Dust, Curved	9" (229mm)



Micro Ring Forceps
Counterbalanced, Round Handle

RN8295

Catalog#	Length
RN0188	7" (178mm)
RN0189	9" (229mm)



RN0188

Micro Forceps with Catch
Flat Handle

Catalog#	Description	Length
R8230	Strongly Curved Jaws	7" (178mm)
R8231	Slightly Curved Jaws	7" (178mm)



Micro Forceps
Flat, Bayonet Handle

R8230

Catalog#	Description	Length
R8250	Straight, Normal	8 ³ / ₄ " (222mm)
R8251	Straight, Extra Fine	8 ³ / ₄ " (222mm)



R8251

Titanium Forceps (not pictured)

Catalog#	Description	Length	Teeth
RB1150T	Adson	4¾" (121mm)	Serrated
RB1154T	Adson	4¾" (121mm)	1 × 2
RB1174T	Cushing	7" (178mm)	Serrated
RB1175T	Cushing	7" (178mm)	1 × 2

DeBakey Forceps

Round Handle

Catalog#	Tip	Handle	Length
RB9187	Delicate	Round	7¼" (184mm)
RB9188	Delicate	Round	8¼" (210mm)



RB9187

McCravey Tissue Forceps

Catalog#	Length
R0455	7" (178mm)



R0455

Adson Bayonet Forceps

Catalog#	Length
R0462	7¼" (184mm)



R0463

Yasargil Bayonet Forceps (new style)

Catalog#	Length	Tip
RB9137	7" (178mm)	0.5mm
RB9138	7" (178mm)	1mm
RB9139	7" (178mm)	1 × 2
RB9140	8" (203mm)	0.5mm
RB9141	8" (203mm)	1mm
RB9142	8¾" (222mm)	0.5mm
RB9143	8¾" (222mm)	1mm
RB9144	9½" (241mm)	0.5mm
RB9145	9½" (241mm)	1mm



Potts-Smith Dressing Forceps with Tungsten-Carbide Inserts

Flat Handle

Catalog#	Length	Tip
R0439	7½" (191mm)	2 × 10mm



R0439

Flat Handled Gerald Forceps

Flat Handle

Catalog#	Description	Length	Teeth
R0435	Straight	7" (178mm)	Tissue, 1 × 2
R0437	Straight	7" (178mm)	Dressing
R0440	Curved	7" (178mm)	Tissue, 1 × 2
R0442	Curved	7" (178mm)	Dressing



R0437

Yasargil Bayonet Forceps
Flat Handle

Catalog#	Description	Length
RN8032	Sharp	7¼" (184mm)
RN8033	Blunt	7¼" (184mm)
RN8030	Sharp	8¼" (210mm)
RN8031	Blunt	8¼" (210mm)
RN8029	Sharp	9" (229mm)
RN8028	Blunt	9" (229mm)



RN8030



Blunt

Yasargil Bayonet Tumor Forceps
Flat Handle

Catalog#	Jaw	Length
RN8034	3mm Spoon Shaped	9" (229mm)
RN8036	3mm Serrated, Flat	9" (229mm)



RN8034



Semken Forceps with Tungsten-Carbide Inserts
Flat Handle

Catalog#	Length	Teeth
RT0145	6" (152mm)	1 × 2
RT0146	6" (152mm)	Serrated



RT0145

Iris Bipolar Straight Forceps

Catalog#	Description	Length	Tip
R2645	Straight	3½" (90mm)	0.3mm
R2646	Curved	3½" (90mm)	0.3mm



R2646

Semken Bipolar Straight Forceps

Catalog#	Description	Length	Tip
R2640	Straight	5¼" (133mm)	0.7mm



R2640

Adson Bipolar Forceps

Catalog#	Length	Tip
RB9221	4¾" (121mm)	1mm



RB9221

Jeweler's Bipolar Forceps

Catalog#	Length	Tip
RB9222	4¾" (121mm)	0.2mm



RB9222

Cushing Bipolar Forceps

Catalog#	Length	Tip
RB9224	6" (152mm)	1mm



RB9224



Microsurgical Bipolar Bayonet Forceps

Catalog#	Description	Length	Tip
R2620	40° Down	7¼" (184mm)	0.6mm
R2696	Straight	7¼" (184mm)	0.6mm



Transphenoidal Hypophysectomy Bipolar Bayonet Forceps

Catalog#	Description	Length	Tip
R2697	Straight	8½" (216mm)	0.7mm
R2698	Straight, Insulated	8½" (216mm)	0.7mm



Gerald Bipolar Bayonet Forceps

Catalog#	Length	Tip
RB9227	7" (178mm)	1mm



Rhoton Bipolar Bayonet Forceps

Catalog#	Length	Tip
RB9243	8½" (216mm)	1mm



Hardy Style Bipolar Bayonet Forceps



RR2204

Catalog#	Description	Length	Tips
RR2201	Irrigated, Insulated, Straight	8½" (216mm)	0.2mm
RR2202	Irrigated, Insulated, Straight	8½" (216mm)	0.4mm
RR2203	Irrigated, Insulated, Straight	8½" (216mm)	0.5mm
RR2204	Irrigated, Insulated, Straight	8½" (216mm)	0.7mm
RR2205	Irrigated, Insulated, Straight	8½" (216mm)	1.0mm
RR2206	Irrigated, Insulated, Straight	8½" (216mm)	1.3mm
RR2207	Irrigated, Insulated, Straight	8½" (216mm)	1.5mm
RR2208	Irrigated, Insulated, Straight	8½" (216mm)	1.7mm
RR2209	Irrigated, Insulated, Straight	8½" (216mm)	2.0mm
RR2301	Irrigated, Insulated, 45° Angle Down	8½" (216mm)	0.2mm
RR2302	Irrigated, Insulated, 45° Angle Down	8½" (216mm)	0.4mm
RR2303	Irrigated, Insulated, 45° Angle Down	8½" (216mm)	0.5mm
RR2304	Irrigated, Insulated, 45° Angle Down	8½" (216mm)	0.7mm
RR2305	Irrigated, Insulated, 45° Angle Down	8½" (216mm)	1.0mm
RR2306	Irrigated, Insulated, 45° Angle Down	8½" (216mm)	1.3mm
RR2307	Irrigated, Insulated, 45° Angle Down	8½" (216mm)	1.5mm
RR2308	Irrigated, Insulated, 45° Angle Down	8½" (216mm)	1.7mm
RR2309	Irrigated, Insulated, 45° Angle Down	8½" (216mm)	2.0mm
RR2401	Irrigated, Insulated, 45° Angle Up	8½" (216mm)	0.2mm
RR2402	Irrigated, Insulated, 45° Angle Up	8½" (216mm)	0.4mm
RR2403	Irrigated, Insulated, 45° Angle Up	8½" (216mm)	0.5mm
RR2404	Irrigated, Insulated, 45° Angle Up	8½" (216mm)	0.7mm
RR2405	Irrigated, Insulated, 45° Angle Up	8½" (216mm)	1.0mm
RR2406	Irrigated, Insulated, 45° Angle Up	8½" (216mm)	1.3mm
RR2407	Irrigated, Insulated, 45° Angle Up	8½" (216mm)	1.5mm
RR2408	Irrigated, Insulated, 45° Angle Up	8½" (216mm)	1.7mm
RR2409	Irrigated, Insulated, 45° Angle Up	8½" (216mm)	2.0mm
RR2501	Insulated, Straight	8½" (216mm)	0.2mm
RR2502	Insulated, Straight	8½" (216mm)	0.4mm
RR2503	Insulated, Straight	8½" (216mm)	0.5mm
RR2504	Insulated, Straight	8½" (216mm)	0.7mm
RR2505	Insulated, Straight	8½" (216mm)	1.0mm
RR2506	Insulated, Straight	8½" (216mm)	1.3mm
RR2507	Insulated, Straight	8½" (216mm)	1.5mm
RR2508	Insulated, Straight	8½" (216mm)	1.7mm
RR2509	Insulated, Straight	8½" (216mm)	2.0mm
RB9233	Uninsulated, Straight	8¼" (210mm)	0.7mm



RR2204



RR2304



RR2404



Scoville-Green Style Bipolar Bayonet Forceps

Catalog#	Description	Length	Tips
RR2601	Insulated, Straight	7 ³ / ₄ " (197mm)	0.2mm
RR2602	Insulated, Straight	7 ³ / ₄ " (197mm)	0.4mm
RR2603	Insulated, Straight	7 ³ / ₄ " (197mm)	0.5mm
RR2604	Insulated, Straight	7 ³ / ₄ " (197mm)	0.7mm
RR2605	Insulated, Straight	7 ³ / ₄ " (197mm)	1.0mm
RR2606	Insulated, Straight	7 ³ / ₄ " (197mm)	1.3mm
RR2607	Insulated, Straight	7 ³ / ₄ " (197mm)	1.5mm
RR2608	Insulated, Straight	7 ³ / ₄ " (197mm)	1.7mm
RR2609	Insulated, Straight	7 ³ / ₄ " (197mm)	2.0mm
RB9235	Uninsulated, Straight	7 ¹ / ₄ " (184mm)	1.5mm
RB9236	Insulated, Irrigated, Straight	7 ¹ / ₄ " (184mm)	1.5mm



RR2605

Yasargil Style Bipolar Bayonet Forceps

Catalog#	Description	Length	Tips
RR2701	Irrigated, Straight	6 ¹ / ₄ " (159mm)	0.5mm
RR2702	Irrigated, Straight	6 ¹ / ₄ " (159mm)	0.7mm
RR2703	Irrigated, Straight	6 ¹ / ₄ " (159mm)	1.0mm
RR2704	Irrigated, Straight	6 ¹ / ₄ " (159mm)	1.3mm
RR2705	Irrigated, Straight	7 ¹ / ₈ " (181mm)	0.5mm
RR2706	Irrigated, Straight	7 ¹ / ₈ " (181mm)	0.7mm
RR2707	Irrigated, Straight	7 ¹ / ₈ " (181mm)	1.0mm
RR2708	Irrigated, Straight	7 ¹ / ₈ " (181mm)	1.3mm
RR2709	Irrigated, Straight	7 ⁷ / ₈ " (200mm)	0.5mm
RR2710	Irrigated, Straight	7 ⁷ / ₈ " (200mm)	0.7mm
RR2711	Irrigated, Straight	7 ⁷ / ₈ " (200mm)	1.0mm
RR2712	Irrigated, Straight	7 ⁷ / ₈ " (200mm)	1.3mm
RB9241	Insulated, Straight	7 ⁷ / ₈ " (200mm)	1mm
RB9242	Insulated, Straight	7 ⁷ / ₈ " (200mm)	2mm



RR2711

Titanium Bipolar Bayonet Forceps

Catalog#	Description	Length	Tips
RR2804	Irrigated, Insulated, Straight	8 ³ / ₄ " (222mm)	0.2mm
RR2805	Irrigated, Insulated, Straight	8 ³ / ₄ " (222mm)	0.4mm
RR2806	Irrigated, Insulated, Straight	8 ³ / ₄ " (222mm)	0.5mm
RR2807	Irrigated, Insulated, Straight	8 ³ / ₄ " (222mm)	0.7mm
RR2808	Irrigated, Insulated, Straight	8 ³ / ₄ " (222mm)	1.0mm
RR2809	Irrigated, Insulated, Straight	8 ³ / ₄ " (222mm)	1.3mm
RR2810	Irrigated, Insulated, Straight	8 ³ / ₄ " (222mm)	1.5mm
RR2811	Irrigated, Insulated, Straight	8 ³ / ₄ " (222mm)	1.7mm
RR2812	Irrigated, Insulated, Straight	8 ³ / ₄ " (222mm)	2.0mm



RR2810

Titanium Bipolar Bayonet Forceps

Catalog#	Description	Length	Tip
R2691	Straight	8 ³ / ₄ " (222mm)	1.5mm
R2692	Straight	8 ³ / ₄ " (222mm)	0.5mm
R2693	Straight	8 ³ / ₄ " (222mm)	1mm
R2694	Angled Up	8 ³ / ₄ " (222mm)	0.5mm



R2693

Apfelbaum Bipolar Bayonet Forceps

Catalog#	Description	Length	Tip Size
RN1121	Titanium, Straight	8¾" (222mm)	0.7mm
RN1122	Titanium, Straight	8¾" (222mm)	1mm
RN1123	Titanium, Angled Up	8¾" (222mm)	0.7mm
RN1124	Titanium, Angled Up	8¾" (222mm)	1mm
RN1125	Titanium, Angled Down	8¾" (222mm)	0.7mm
RN1126	Titanium, Angled Down	8¾" (222mm)	1mm
RN1127	Titanium, Straight	10" (254mm)	0.7mm
RN1128	Titanium, Angled Up	10" (254mm)	0.7mm
RN1129	Titanium, Angled Down	10" (254mm)	0.7mm
RN1127N	Insulated, Straight	10" (254mm)	0.7mm
RN1128N	Insulated, Angled Up	10" (254mm)	0.7mm
RN1129N	Insulated, Angled Down	10" (254mm)	0.7mm

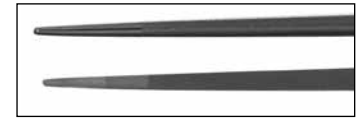

Straight



Up



Down



RN1121

Apfelbaum Bipolar Forceps Tray

Instruments Not Included

Catalog#	Description
RS1120	Single Level Holds RN1121 through RN1129N 14½" L × 11½" W × 1½" D



RS1120

M-Style Bipolar Forceps

Bayonet

Catalog#	Description	Length	Tip
RB9228		7 ³ / ₄ " (197mm)	1.5mm
RB9229	Insulated, Irrigated	8 ¹ / ₂ " (216mm)	0.7mm
RB9230	Insulated, Irrigated	8 ³ / ₄ " (222mm)	1mm
RB9231		7" (178mm)	1.5mm



RB9228



RB9229

M-Jensen Bipolar Forceps

Catalog#	Length	Tip
RB9232	7 ³ / ₄ " (197mm)	0.25mm



RB9232



BUZZ™ Non-stick Bayonet Bipolar Forceps

Catalog No.	Description	Length	Working Length	Tip
NI5BS03	w/stop	5.43" (138mm)	2.05" (52mm)	0.3mm
NI5BS06	w/stop	5.43" (138mm)	2.05" (52mm)	0.6mm
NI5BS10	w/stop	5.43" (138mm)	2.05" (52mm)	1mm
NI5BS20	w/stop	5.43" (138mm)	2.05" (52mm)	2mm
NI8BS03	w/stop	6.61" (168mm)	3.27" (83mm)	0.3mm
NI8BS06	w/stop	6.61" (168mm)	3.27" (83mm)	0.6mm
NI8BS10	w/stop	6.61" (168mm)	3.27" (83mm)	1mm
NI8BS20	w/stop	6.61" (168mm)	3.27" (83mm)	2mm
N20BS03	w/stop	7.32" (186mm)	3.86" (98mm)	0.3mm
N20BS06	w/stop	7.32" (186mm)	3.86" (98mm)	0.6mm
N20BS10	w/stop	7.32" (186mm)	3.86" (98mm)	1mm
N20BS20	w/stop	7.32" (186mm)	3.86" (98mm)	2mm
N22BS03	w/stop	8.11" (206mm)	4.65" (118mm)	0.3mm
N22BS06	w/stop	8.11" (206mm)	4.65" (118mm)	0.6mm
N22BS10	w/stop	8.11" (206mm)	4.65" (118mm)	1mm
N22BS20	w/stop	8.11" (206mm)	4.65" (118mm)	2mm
N24BS03	w/stop	8.86" (225mm)	5.43" (138mm)	0.3mm
N24BS06	w/stop	8.86" (225mm)	5.43" (138mm)	0.6mm
N24BS10	w/stop	8.86" (225mm)	5.43" (138mm)	1mm
N24BS20	w/stop	8.86" (225mm)	5.43" (138mm)	2mm
N20BAU10	w/stop, 45° angled up tip	7.17" (182mm)	3.86" (98mm)	1mm
N20BAD10	w/stop, 45° angled down tip	7.17" (182mm)	3.86" (98mm)	1mm
N22BAU10	w/stop, 45° angled up tip	8.03" (204mm)	4.61" (117mm)	1mm
N22BAD10	w/stop, 45° angled down tip	8.03" (204mm)	4.61" (117mm)	1mm
NI15BS10	Irrigated, w/stop	5.43" (138mm)	2.05" (52mm)	1mm
NI18BS06	Irrigated, w/stop	6.61" (168mm)	3.27" (83mm)	0.6mm
NI22BS06	Irrigated, w/stop	8.11" (206mm)	4.65" (118mm)	0.6mm
NI22BS10	Irrigated, w/stop	8.11" (206mm)	4.65" (118mm)	1mm
NI22BS20	Irrigated, w/stop	8.11" (206mm)	4.65" (118mm)	2mm



N20BS10

BUZZ™ Non-stick Cushing Bipolar Forceps

Catalog No.	Description	Length	Working Length	Tip
NI9C07		7.60" (193mm)	3.35" (85mm)	0.7mm
NI9C12		7.60" (193mm)	3.35" (85mm)	1.2mm
NI9C15		7.60" (193mm)	3.35" (85mm)	1.5mm
NI19C07	Irrigated	7.60" (193mm)	3.35" (85mm)	0.7mm
NI19C15	Irrigated	7.60" (193mm)	3.35" (85mm)	1.5mm



NI9C15

BUZZ Non-stick Scoville-Greenwood Bipolar Forceps

Catalog No.	Description	Length	Working Length	Tip
N20SG15		7.80" (198mm)	2.68" (68mm)	1.5mm
NI20SG10	Irrigated	7.80" (198mm)	2.68" (68mm)	1mm
NI20SG15	Irrigated	7.80" (198mm)	2.68" (68mm)	1.5mm
NI20SG20	Irrigated	7.80" (198mm)	2.68" (68mm)	2mm



N20SG15



BUZZ™ Non-stick Hardy Bipolar Forceps

Catalog No.	Description	Length	Working Length	Tip
NH02	w/stop	8.50" (216mm)	4.41" (112mm)	0.2mm
NH04	w/stop	8.50" (216mm)	4.41" (112mm)	0.4mm
NH05	w/stop	8.50" (216mm)	4.41" (112mm)	0.5mm
NH07	w/stop	8.50" (216mm)	4.41" (112mm)	0.7mm
NH10	w/stop	8.50" (216mm)	4.41" (112mm)	1mm
NH13	w/stop	8.50" (216mm)	4.41" (112mm)	1.3mm
NH15	w/stop	8.50" (216mm)	4.41" (112mm)	1.5mm
NH17	w/stop	8.50" (216mm)	4.41" (112mm)	1.7mm
NH20	w/stop	8.50" (216mm)	4.41" (112mm)	2mm
NHAD02	w/stop, 45° angle down tip	8.50" (216mm)	4.41" (112mm)	0.2mm
NHAD04	w/stop, 45° angle down tip	8.50" (21.6cmm)	4.41" (112mm)	0.4mm
NHAD05	w/stop, 45° angle down tip	8.50" (21.6cmm)	4.41" (112mm)	0.5mm
NHAD07	w/stop, 45° angle down tip	8.50" (21.6cmm)	4.41" (112mm)	0.7mm
NHAD10	w/stop, 45° angle down tip	8.50" (21.6cmm)	4.41" (112mm)	1mm
NHAD13	w/stop, 45° angle down tip	8.50" (21.6cmm)	4.41" (112mm)	1.3mm
NHAD15	w/stop, 45° angle down tip	8.50" (21.6cmm)	4.41" (112mm)	1.5mm
NHAD17	w/stop, 45° angle down tip	8.50" (21.6cmm)	4.41" (112mm)	1.7mm
NHAD20	w/stop, 45° angle down tip	8.50" (21.6cmm)	4.41" (112mm)	2mm
NHAU02	w/stop, 45° angle up tip	8.50" (21.6cmm)	4.41" (112mm)	0.2mm
NHAU04	w/stop, 45° angle up tip	8.50" (21.6cmm)	4.41" (112mm)	0.4mm
NHAU05	w/stop, 45° angle up tip	8.50" (21.6cmm)	4.41" (112mm)	0.5mm
NHAU07	w/stop, 45° angle up tip	8.50" (21.6cmm)	4.41" (112mm)	0.7mm
NHAU10	w/stop, 45° angle up tip	8.50" (21.6cmm)	4.41" (112mm)	1mm
NHAU13	w/stop, 45° angle up tip	8.50" (21.6cmm)	4.41" (112mm)	1.3mm
NHAU15	w/stop, 45° angle up tip	8.50" (21.6cmm)	4.41" (112mm)	1.5mm
NHAU17	w/stop, 45° angle up tip	8.50" (21.6cmm)	4.41" (112mm)	1.7mm
NHAU20	w/stop, 45° angle up tip	8.50" (21.6cmm)	4.41" (112mm)	2mm
NHII0	Irrigated, w/stop	8.50" (21.6cmm)	4.41" (112mm)	1mm
NHII5	Irrigated, w/stop	8.50" (21.6cmm)	4.41" (112mm)	1.5mm



NH10





BUZZ™ Non-stick Jeweler Bipolar Forceps

Catalog No.	Length	Tip
N11J025	4.45" (113mm)	0.25mm
N11J06	4.45" (113mm)	0.6mm
N11J10	4.45" (113mm)	1mm



N11J10

BUZZ™ Non-stick Adson Bipolar Forceps

Catalog No.	Length	Tip
N125A07	5.20" (132cm)	0.7mm
N125A12	5.20" (132cm)	1.2mm



N125A12

BUZZ™ Non-stick Semken Bipolar Forceps

Catalog No.	Length	Tip
N15S12	6.14" (156mm)	1.2mm



N15S12

BUZZ™ Non-stick Straight Bipolar Forceps

Catalog No.	Description	Length	Tip
NI5S03	w/stop	5.39" (137mm)	0.3mm
NI5S06	w/stop	5.39" (137mm)	0.6mm
NI5SI0	w/stop	5.39" (137mm)	1mm
NI5S20	w/stop	5.39" (137mm)	2mm
NI8S03	w/stop	6.57" (167mm)	0.3mm
NI8S06	w/stop	6.57" (167mm)	0.6 mm
NI8SI0	w/stop	6.57" (167mm)	1mm
N20S03	w/stop	7.28" (185mm)	0.3mm
N20SI0	w/stop	7.28" (185mm)	1mm
N20S20	w/stop	7.28" (185mm)	2mm
N22S03	w/stop	8.15" (207mm)	0.3mm
N22SI0	w/stop	8.15" (207mm)	1mm
N22S20	w/stop	8.15" (207mm)	2mm
NI5SA03	w/stop, angled tip	5.31" (135mm)	0.3mm
NI5SA10	w/stop, angled tip	5.31" (135mm)	1mm
NI5SA20	w/stop, angled tip	5.31" (135mm)	2mm
NI8SA03	w/stop, angled tip	6.30" (160mm)	0.3mm
NI8SA06	w/stop, angled tip	6.30" (160mm)	0.6mm
NI8SA10	w/stop, angled tip	6.30" (160mm)	1mm
N20SA03	w/stop, angled tip	7.20" (183mm)	0.3mm
N20SA10	w/stop, angled tip	7.20" (183mm)	1mm
N20SA20	w/stop, angled tip	7.20" (183mm)	2mm
N22SA03	w/stop, angled tip	8.07" (205mm)	0.3mm
N22SA10	w/stop, angled tip	8.07" (205mm)	1mm
N22SA20	w/stop, angled tip	8.07" (205mm)	2 mm



NI5SI0



BUZZ Lite™ Non-stick Bayonet Bipolar Forceps

Catalog No.	Description	Length	Working Length	Tip
NI0BL03	w/stop	7.48" (190mm)	3.94" (100mm)	0.3mm
NI0BL06	w/stop	7.48" (190mm)	3.94" (100mm)	0.6mm
NI0BL13	w/stop	7.48" (190mm)	3.94" (100mm)	1.3mm
NI0BL17	w/stop	7.48" (190mm)	3.94" (100mm)	1.7mm
NI3BLA15	w/stop, 15° angled up tip	8.66" (220mm)	5.12" (130mm)	0.6mm
NI3BLA30	w/stop, 30° angled up tip	8.66" (220mm)	5.12" (130mm)	0.6mm
NI3BLA45	w/stop, 45° angled up tip	8.66" (220mm)	5.12" (130mm)	0.6mm
NI3BL03	w/stop	8.66" (220mm)	5.12" (130mm)	0.3mm
NI3BL06	w/stop	8.66" (220mm)	5.12" (130mm)	0.6mm
NI3BL13	w/stop	8.66" (220mm)	5.12" (130mm)	1.3mm
NI3BL17	w/stop	8.66" (220mm)	5.12" (130mm)	1.7mm
NI5BL03	w/stop	9.45" (240mm)	5.91" (150mm)	0.3mm
NI5BL06	w/stop	9.45" (240mm)	5.91" (150mm)	0.6mm
NI5BL13	w/stop	9.45" (240mm)	5.91" (150mm)	1.3mm
NI5BL17	w/stop	9.45" (240mm)	5.91" (150mm)	1.7mm
NI7BL03	w/stop	10.04" (255mm)	6.69" (170mm)	0.3mm
NI7BL06	w/stop	10.04" (255mm)	6.69" (170mm)	0.6mm
NI7BL13	w/stop	10.04" (255mm)	6.69" (170mm)	1.3mm
NI7BL17	w/stop	10.04" (255mm)	6.69" (170mm)	1.7mm



BUZZ™ Accessories

NRBC118	Reusable bipolar forceps cord 118" (3.0m) (2 pin connector)
NBT35	Tray, fits up to 5 Forceps
NBT10	Tray, fits up to 10 Forceps
NBCLOTH	Polishing Cloth
BUZZSTYLET	Stylet for BUZZ™ Irrigating Bipolar Forceps

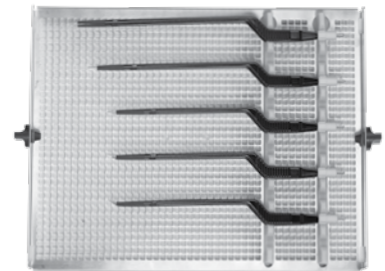

NBT10

Micro Scissors

Round Handle

Catalog#	Description	Length	Tip Length
RN6240	Straight	7" (178mm)	10mm
RN6241	Curved	7" (178mm)	10mm
RN8060	Straight, Long	7" (178mm)	14mm
RN8061	Curved, Long	7" (178mm)	14mm



RN8060

Micro Scissors

Round Handle

Catalog#	Description	Length	Tip Length
R8312	60° Angled	7" (178mm)	12mm

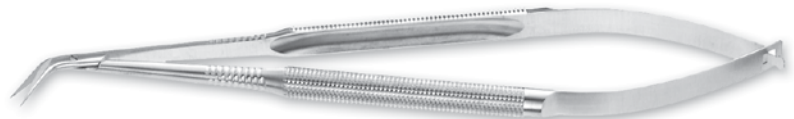

R8312

Jacobson Scissors

Flat Handle

Catalog#	Description	Length
RN8142	Straight	7¼" (184mm)
RN8143	Curved	7¼" (184mm)
RN8144	Angled	7¼" (184mm)



RN8142





Rhoton Style Micro Scissors

Round Handle

Straight	Curved	Length	Tip Length
RB9022	Round Handle	7" (178mm)	14mm
RB9023	Round Handle	7" (178mm)	14mm



RB9022

Evandro De Oliveira Micro Scissors

Round Handle

Catalog#	Blade	Length	Tip Length
RB9006	Straight	6" (152mm)	14mm
RB9008	Straight	7" (178mm)	14mm
RB9010	Straight	8" (203mm)	14mm
RB9011	Curved	7" (178mm)	14mm



RB9008

Yasargil Scissors

Flat Handle

Catalog#	Blade	Length	Tip Length
RB8951	Straight	6 1/4" (159mm)	14mm
RB8952	Curved	6 1/4" (159mm)	14mm



RB8951

Nagel Micro Scissors

Catalog#	Blade	Length
RB9129	45° Lateral Angle	8" (203mm)

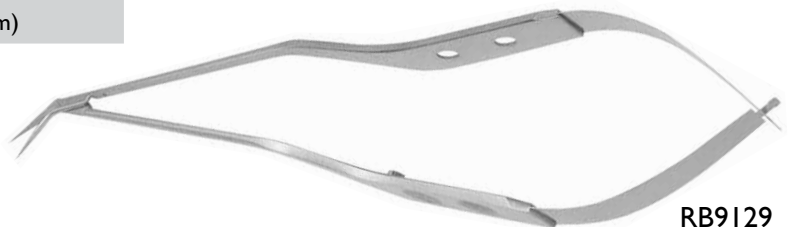

RB9129

Micro Bayonet Scissors

Round Handle

Catalog#	Description	Blades	Length
RN6253	Round Handle	Straight	8¾" (222mm)
RN6254	Round Handle	Curved	8¾" (222mm)
RN6255	Round Handle	Straight	9¼" (235mm)
RN6256	Round Handle	Curved	9¼" (235mm)
RN8065	Round Handle	Straight	8¼" (210mm)
RN8066	Round Handle	Curved	8¼" (210mm)



RN6254

Jacobson Micro Bayonet Scissors

Flat Handle

Catalog#	Description	Length	Tip Length
RN8145	Straight	7¼" (184mm)	13mm
RN8146	Curved	7¼" (184mm)	13mm
RN8147	Angled	7¼" (184mm)	13mm
RN8148	Micro Straight	7¼" (184mm)	10mm
RN8149	Micro Curved	7¼" (184mm)	10mm



RN8148

Yasargil Micro Bayonet Scissors

Flat Handle

Catalog#	Description	Blades	Length
RN8020	Flat Handle	Straight	8¾" (222mm)
RN8021	Flat Handle	Curved	8¾" (222mm)
RN8022	Flat Handle	Micro Straight	9" (229mm)
RN8023	Flat Handle	Micro Curved	9" (229mm)



RN8022

Yasargil Micro Bayonet Scissors (new style)

Flat Handle

Catalog#	Blade	Length
RB9110	Straight	6½" (165mm)
RB9111	Curved Up	6½" (165mm)
RB9112	Straight, Dissecting	6½" (165mm)
RB9113	Straight, Dissecting	7½" (191mm)
RB9114	Straight, Serrated	8" (203mm)
RB9115	Curved Up, Serrated	8" (203mm)
RB9116	Curved Down, Serrated	8" (203mm)
RB9120	Straight	9" (229mm)
RB9121	Curved	9" (229mm)
RB9122	Curved Up	9" (229mm)
RB9124	Curved, Micro Tip	9" (229mm)
RB9123	Straight, Micro Tip	9" (229mm)
RB9125	Straight, Dissecting	9" (229mm)
RB9126	Curved, Dissecting	9" (229mm)
RB9127	45° Lateral Angle, with Ball	8" (203mm)
RB9128	125° Lateral Angle	7½" (191mm)



RB9115



RB9127



RB9128



Micro Serrated Bayonet Scissors

The serrations firmly hold tissue in place for easy cutting. The scissor blades stay sharp longer.

Sharp, Flat Handle

Catalog#	Blades	Length
RN8001	Straight	9¼" (234mm)
RN8002	Up	9¼" (234mm)
RN8003	Down	9¼" (234mm)
RN8004	Straight	10½" (267mm)
RN8005	Up	10½" (267mm)
RN8006	Straight	8¼" (210mm)
RN8007	Up	8¼" (210mm)
RN8008	Straight	7¼" (184mm)
RN8009	Up	7¼" (184mm)



Straight



Up



Down

Blunt, Flat Handle

Catalog#	Blades	Length
RN8001B	Straight	9¼" (234mm)
RN8002B	Up	9¼" (234mm)
RN8003B	Down	9¼" (234mm)
RN8004B	Straight	10½" (267mm)
RN8005B	Up	10½" (267mm)
RN8006B	Straight	8¼" (210mm)
RN8007B	Up	8¼" (210mm)
RN8008B	Straight	7¼" (184mm)
RN8009B	Up	7¼" (184mm)

Micro Serrated Bayonet Scissors Tray

Instruments Not Included

Catalog#	Description
RS8000	Sharp Holds RN8001 through RN8009 Holds RN8001B through RN8009B

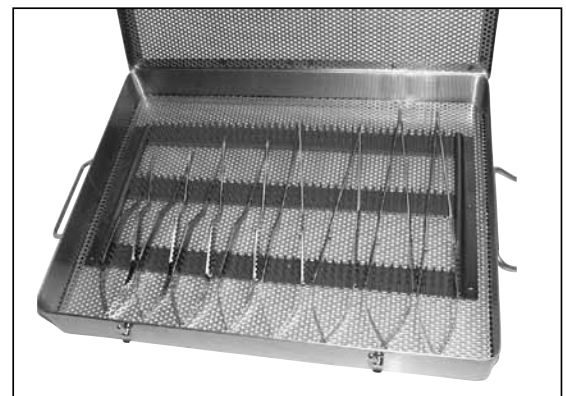

RS8000

Fukushima-Giannotta Micro Bayonet Scissors
Flat Handle



R8924

Catalog#	Blades	Length
R8924	Straight, Long, Blunt	8" (203mm)
R8925	Straight	7¼" (184mm)
R8926	Curved Up	7¼" (184mm)
R8927	Straight	8" (203mm)
R8928	Curved Up	8" (203mm)
R8929	Straight	8¾" (222mm)
R8930	Curved Up	8¾" (222mm)
R8931	Curved Up, Very Fine	8" (203mm)
R8931S	Curved Up, Very Fine	7¼" (184mm)
R8932	Curved Up	9½" (241 mm)



R8925



R8926



R8927



R8928



R8929

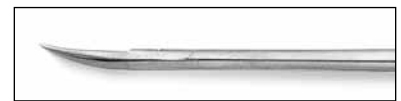

R8930

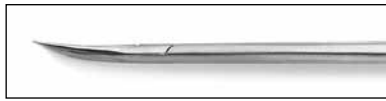

R8931



R8931S



R8932

Fukushima-Giannotta Micro Bayonet Needle Holders
Flat Handle

Catalog#	Blades	Length
R8933	Straight	7¾" (197mm)
R8934	Curved Up	7¾" (197mm)



R8933

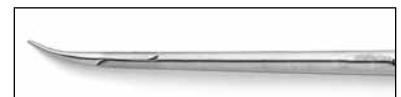

R8934

Titanium Straight Scissors

Flat Handle

Catalog#	Blades	Length
651365	Straight	6½" (165mm)
651366	Straight	6½" (165mm)



651365

Titanium Round Handled Straight Scissors

Flat Handle

Catalog#	Blades	Length
651375	Standard	7¼" (184mm)
651376	Curved	7¼" (184mm)



651376

Titanium Bayonet Scissors

Round Handle

Catalog#	Blades	Length
651367	Straight/Regular	8⅝" (219mm)
651370	Straight/Fine	8⅝" (219mm)
651368	Curved Up/Regular	8⅝" (219mm)
651371	Curved Up/Fine	8⅝" (219mm)
651369	Curved Down/Regular	8⅝" (219mm)



651367

Titanium Round Handled Bayonet Scissors

Round Handle

Catalog#	Blades	Length
651377	Straight	8⅝" (219mm)
651378	Curved	8⅝" (219mm)



651377

Jacobson Micro Needle Holder
Round Handle

Catalog#	Description	Jaws	Length
RN8297	with Lock	Straight	7" (178mm)
RN8298	with Lock	Straight	8¼" (210mm)
RN8299	with Lock	Straight	9" (229mm)



RN8297

Jacobson Micro Needle Holder
Flat Handle

Catalog#	Description	Jaws	Length
RN8275	with Lock	Straight	7" (178mm)
RN8276	without Lock	Straight	7" (178mm)



RN8275

Jacobson Micro Bayonet Needle Holder
Flat Handle

Catalog#	Jaws	Length
RN8136	Straight	7¼" (184mm)
RN8137	Curved	7¼" (184mm)



RN8137



Micro Bayonet Needle Holder
Round Handle

Catalog#	Jaws	Length
RN6271	Straight	8½" (216mm)
RN6272	Curved	8½" (216mm)
RN6273	Straight	9¼" (235mm)
RN6274	Curved	9¼" (235mm)



RN6271

Micro Needle Holder With Lock
Flat Handle

Catalog#	Jaws	Length
R8210	Slightly Curved	7" (178mm)



R8210

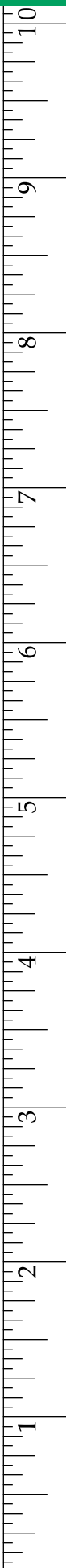

Yasargil Micro Bayonet Needle Holder

Flat Handle

Catalog#	Jaws	Length
RN8025	Straight	9¼" (235mm)
RN8026	Curved	9¼" (235mm)



RN8026

Yasargil Micro Bayonet Needle Holder (new style)

Flat Handle

Catalog#	Jaws	Length
RB9250	Straight	8" (203mm)
RB9251	Curved	8" (203mm)
RB9252	Straight	9" (229mm)
RB9253	Curved	9" (229mm)



Titanium Bayonet Needle Holder With Lock
Flat Handle

Catalog#	Jaws	Length	Tip Width
651388	Straight	8½" (216mm)	1mm
651389	Straight	8½" (216mm)	0.5mm
651390	Curved	8½" (216mm)	1mm



651388

Titanium Round Handled Bayonet Needle Holder
Round Handle

Catalog#	Tips	Length	Tip Width
651394	Straight	8½" (216mm)	1mm
651395	Curved	8½" (216mm)	1mm



651394



Kurze Dissecting Scissors

Catalog#	Description	Length	Tip Length
RN7021	Straight	5½" (140mm)	8.5mm
RN7022	Curved Left	5½" (140mm)	8.5mm
RN7023	Curved Right	5½" (140mm)	8.5mm

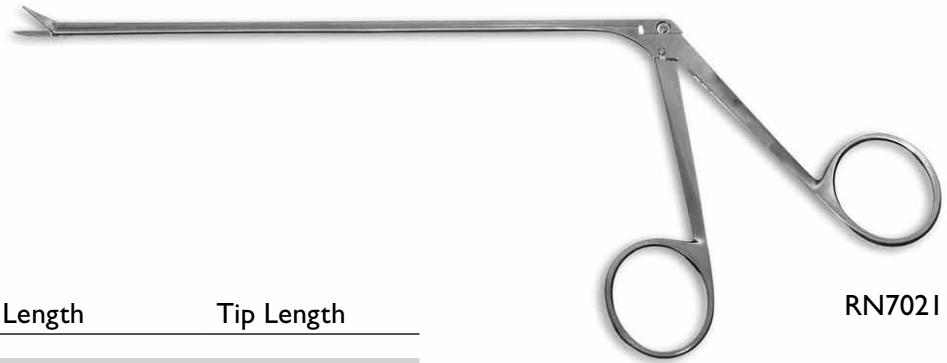

Nasal Scissors

Catalog#	Description	Length	Tip Length
RN7061	Adult Straight	5⅛" (130mm)	15mm



Olivecrona Alligator Scissors

Catalog#	Length	Tip Length
R1925	6" (152mm)	18mm



Ring Handled Microsurgical Forceps

Catalog#	Tips	Length	Tip
R8850	Straight	5¼" (133mm)	0.5mm
R8851	Angled Right	5¼" (133mm)	0.5mm
R8852	Angled Left	5¼" (133mm)	0.5mm
R8855	Straight	5¼" (133mm)	1mm
R8856	Angled Right	5¼" (133mm)	1mm
R8857	Angled Left	5¼" (133mm)	1mm
R8858	Straight	5¼" (133mm)	2mm

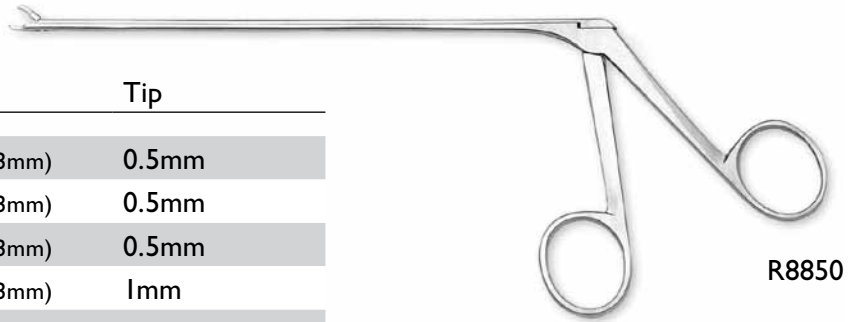

R8850

Micro Alligator Grasping Forceps and Scissors Stationary Lower Jaw

Catalog#	Description	Length	Tip
R8645	Round Cup	7¼" (184mm)	2mm
R8646	Round Cup	7¼" (184mm)	1mm
R8647	Scissors	7¼" (184mm)	5mm

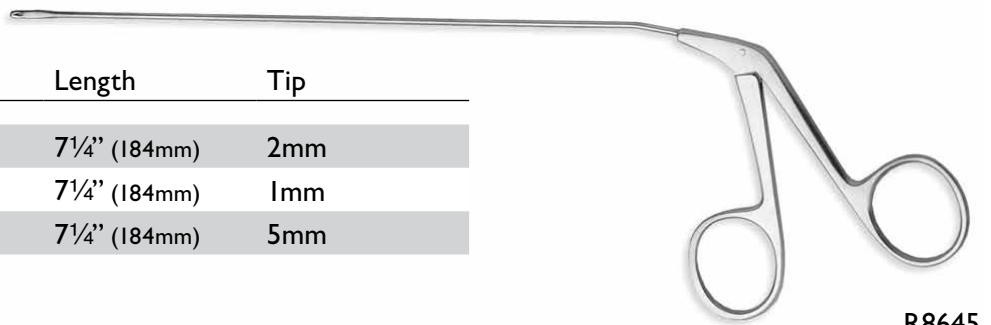

R8645

Ring Handled Microsurgical Scissors

Catalog#	Blades	Length	Tip Length
R8860	Blunt, Straight	5½" (140mm)	8mm
R8861	Blunt, Curved Right	5½" (140mm)	8mm
R8862	Blunt, Curved Left	5½" (140mm)	8mm

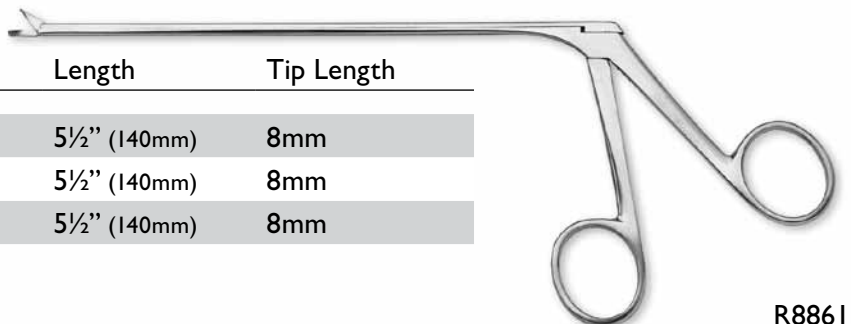

R8861

Belluci Micro Alligator Scissors

Catalog#	Blades	Length	Tip Length
R8658	Straight, Delicate	5½" (140mm)	5.5mm
R8659	Curved, Delicate	5½" (140mm)	5.5mm

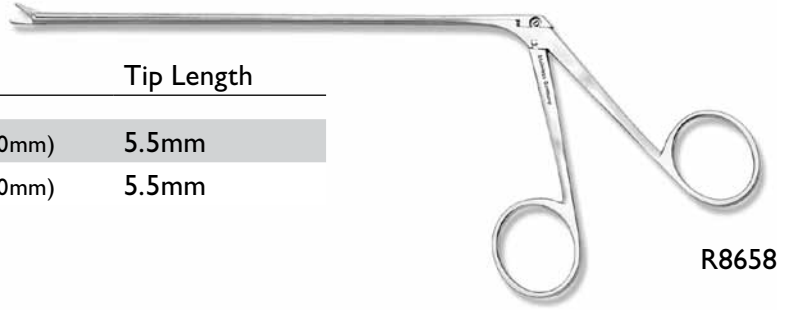

R8658

Micro Cup Forceps

Catalog#	Cup	Length	Tip
RB9617	Straight	7¾" (197mm)	2.5mm
RB9618	Up	7¾" (197mm)	2.5mm
RB9619	Down	7¾" (197mm)	2.5mm

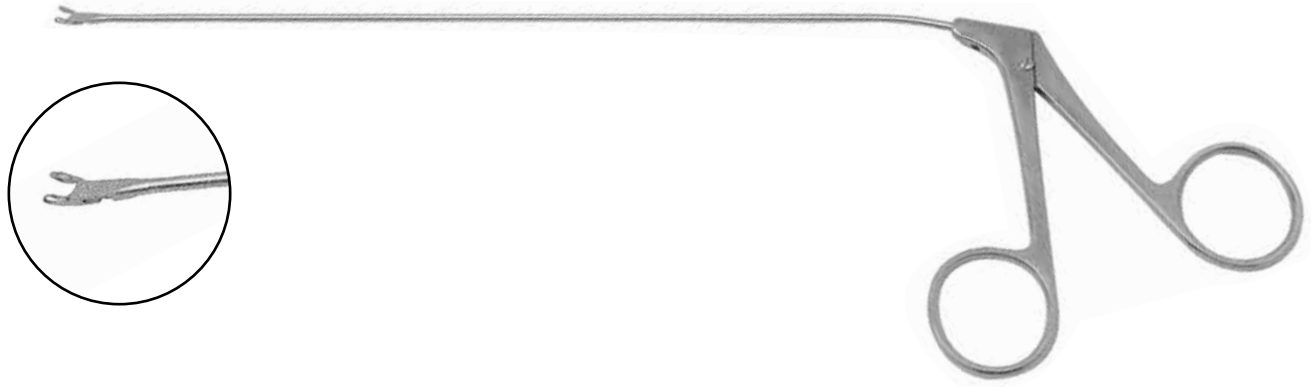

RB9617

Weil-Blakesley Forceps

Catalog#	Description	Length
RN5423	#1, 45° Up	4½" (114mm)
RN5424	#1, Straight	4½" (114mm)



RN5423



Flat Handle Hartman Alligator Forceps

Catalog#	Length	Teeth
R0506	7¼" (184mm)	Serrated



R0506

Raney Clip Applying Forceps

Catalog#	Length
RN0140	6¼" (159mm)



RN0140

Septal Breaker

Catalog#	Description	Length
RN0331	Up Opening	6¼" (159mm)
RN0332	Down Opening	6¼" (159mm)
RN0330	Pair of Up and Down Opening	

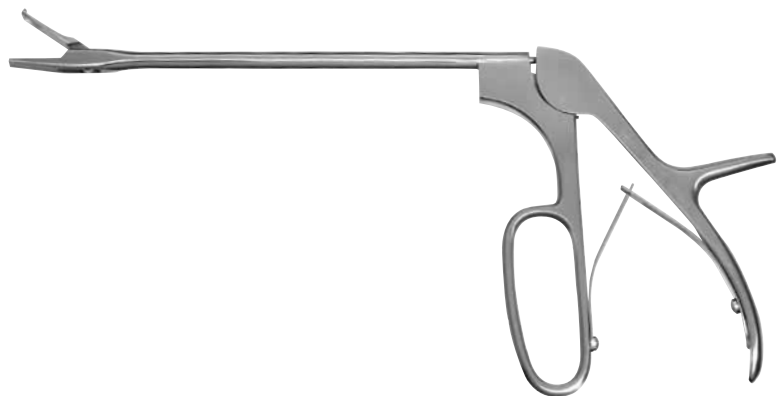

RN0331



RUGGLES™ Speculum

Catalog#	Length
R7401	70mm
R7402	88mm
R7403	110mm



R7401

Killian Septum Speculum

Catalog#	Length
R8535	50mm
R8536	65mm
R8537	77mm
R8538	91mm



R8535

Transphenoidal Speculum Black

Catalog#	Length
RN2575	70mm
RN2576	80mm
RN2577	90mm
RN2578	100mm



RN2578

Swivel Knife

Catalog#	Description	Width
R8520	Straight	3mm
R8521	Straight	4mm
R8522	Straight	5mm
R8525	Bayonet	3mm
R8526	Bayonet	4mm
R8527	Bayonet	5mm



R8520

Jansen-Middleton Forceps

Catalog#	Working Length	Tip
R8530	4" (102mm)	5 × 12.5mm
RB9477		6 × 16mm



R8530

Fukushima Transphenoidal Micro Ring Curettes

9" (229mm) Length



R8865

Catalog#	Description	Ring Diameter
R8865	30° Angle	2mm
R8866	45° Angle	2mm
R8867	30° Angle	2.5mm
R8868	45° Angle	2.5mm
R8869	30° Angle	3mm
R8870	50° Angle	3mm
R8871	45° Angle	4mm
R8872	55° Angle	5mm
R8873	45° Angle	6mm
R8874	45° Angle	7mm
R8875	Malleable Shaft, Straight	5mm



R8866



R8867

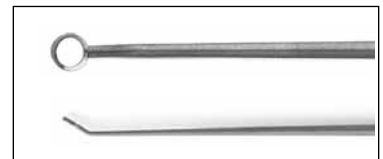

R8868

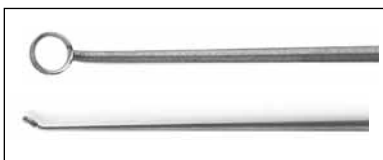

R8869



R8870

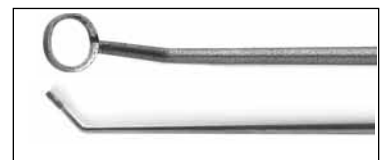

R8871



R8872



R8873



R8874



R8875

Transphenoidal Instruments

9¾" (248mm) Length



RN6302

Catalog#	Description
----------	-------------

RN6300	Transphenoidal Bayonet Curette Set Includes one each of items RN6301 through RN6316 (excluding RN6305L and RN6306L) and one Instrument Tray RN6320
--------	---

Ring Curettes

Catalog#	Description	Ring Size
----------	-------------	-----------

RN6301	Angle Up	3mm
RN6302	Angle Up	5mm
RN6303	90° Angle Down	3mm
RN6304	90° Angle Down	5mm
RN6305	45° Angle Right	3mm
RN6305L	45° Angle Left	3mm
RN6306	45° Angle Right	5mm
RN6306L	45° Angle Left	5mm
RN6307	45° Angle Up	3mm
RN6308	45° Angle Up	5mm
RN6323	45° Angle Down	3mm
RN6324	45° Angle Down	5mm



RN6301



RN6302



RN6303

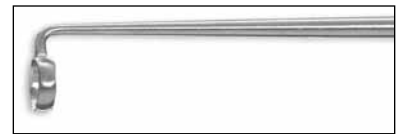

RN6304



RN6305



RN6306



RN6307



RN6308



RN6323



RN6324

RUGGLES™ Transphenoidal Curette Tray

Catalog#	Description
----------	-------------

RN6320	Single Level, RN6320 Holds RN6301 through RN6316
--------	--



RN6320



Transphenoidal Instruments

9³/₄" (248mm) Length

Dissector

Catalog#	Description	Tip Width
RN6309	Angle Up	1.5mm
RN6310	Angle Down	1.5mm

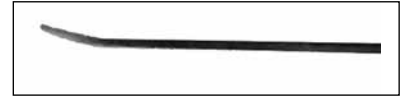

RN6309



RN6310

Eucleator

Catalog#	Description
RN6311	Bayonet Micro, Left
RN6312	Bayonet Micro, Right
RN6313	Bayonet Standard, Left
RN6314	Bayonet Standard, Right



RN6311



RN6312



RN6313



RN6314

Knife Handle

Catalog#	Description
RN6315	Bayonet Vertical
RN6316	Bayonet Lateral



RN6315



RN6316

Endoscopic Endonasal Pituitary Instrument Set

This universal and comprehensive instrument set is intended to be used in conjunction with the Universal Neuro-Endoscope Set to facilitate the endoscopic endonasal pituitary procedure. The set has also been designed with the versatility to accommodate standard microscopic transphenoidal surgical technique.



Catalog# Description

RN5000 Endoscopic Endonasal Pituitary Set
Set includes one each of items listed below and one Instrument Tray RS5000

Catalog#	Instrument	Description	Length
RN0331	Septal Breaker	Up	
RN0326	Cottle Septum Elevator	Double Ended, Graduated	8½" (216mm)
RN0883	Micro Bayonet Curette	Straight, 3-0	
RN4872	Micro Kerrison	2mm, 90° Down	8" (203mm)
RN4882	Micro Kerrison	2mm, 40° Up	8" (203mm)
RN4891	Sella Punch	1mm, 40° Up	8" (203mm)
RN5423	Weil Blakesely Forceps	40° Up, Size I	4½" (114mm)
RN5424	Weil Blakesely Forceps	Straight, Size I	4½" (114mm)
RN5712H	Cushing IVD Rongeur	Straight, 2 × 10mm	7" (178mm)
RN5722H	Cushing IVD Rongeur	Up, 2 × 10mm	7" (178mm)
RN5780	Cushing IVD Rongeur	Straight, 1.5 × 10mm	7" (178mm)
RN6021	Hook	45° Angle	9¾" (248mm)
RN6301	Transphenoidal Bayonet Curette	3mm, 90° Up	9¾" (248mm)
RN6302	Transphenoidal Bayonet Curette	5mm, 90° Up	9¾" (248mm)
RN6303	Transphenoidal Bayonet Curette	3mm, 90° Down	9¾" (248mm)
RN6304	Transphenoidal Bayonet Curette	5mm, 90° Down	9¾" (248mm)
RN6307	Transphenoidal Bayonet Curette	3mm, 45° Up	9¾" (248mm)
RN6308	Transphenoidal Bayonet Curette	5mm, 45° Up	9¾" (248mm)
RN6323	Transphenoidal Bayonet Curette	3mm, 45° Down	9¾" (248mm)
RN6324	Transphenoidal Bayonet Curette	5mm, 45° Down	9¾" (248mm)
RN7021	Kurze Dissecting Scissors	Straight	5¼" (133mm)
RN7022	Kurze Dissecting Scissors	Curved Left	5¼" (133mm)
RN7023	Kurze Dissecting Scissors	Curved Right	5¼" (133mm)
RN7061	Nasal Scissors	Straight	Adult
RN7131	Decker Forceps	Straight, 1.5 × 5mm Cup	6" (152mm)
RN82325	Suction Tube	5 Fr, Angled Short Curved Up	8" (203mm)
RN82327	Suction Tube	7 Fr, Angled Short Curved Up	8" (203mm)
RN82425	Suction Tube	5 Fr, Angled Long Curved Up	8" (203mm)
RN82427	Suction Tube	7 Fr, Angled Long Curved Up	8" (203mm)
RN82525	Suction Tube	5 Fr, Angled Straight Tip	8" (203mm)
RN82527	Suction Tube	7 Fr, Angled Straight Tip	8" (203mm)
RN825211	Suction Tube	11 Fr, Angled Straight Tip	8" (203mm)
RN82625	Suction Tube	5 Fr, Angled Short Curved Down	8" (203mm)
RN82627	Suction Tube	7 Fr, Angled Short Curved Down	8" (203mm)
RN82725	Suction Tube	5 Fr, Angled Long Curved Down	8" (203mm)
RN82727	Suction Tube	7 Fr, Angled Long Curved Down	8" (203mm)

Vinyl Tip Protectors

Packages of 100

Catalog#	Color
R5501	White
R5502	Blue
R5503	Green
R5504	Red
R5505	Yellow
R5506	Maroon
R5507	Orange
R5508	Brown
R5509	Black

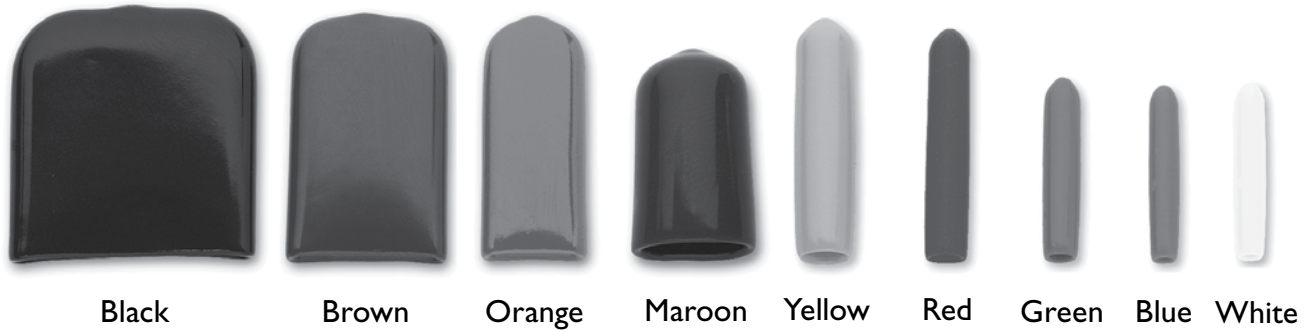

Reflective Spheres

5 pouches/box

Catalog#	Description	Unit
RB8800737	Reflective Spheres	each pouch contains 1 sphere
RB8800738	Reflective Spheres	each pouch contains 3 spheres
RB8800739	Reflective Spheres	each pouch contains 4 spheres



INDEX



ACF Complete System	28	BUZZ™ Non-stick Hardy Bipolar Forceps	188	Dissection Instruments	150-172
Adson Bayonet Forceps	177	BUZZ™ Non-stick Jeweler Bipolar Forceps	190	Dissectors	13-15, 128, 157, 159, 162, 164, 165, 170, 212
Adson Bipolar Forceps	180	BUZZ™ Non-stick Scoville-Greenwood Bipolar Forceps	188	Distraction Screws	28
Adson Cerebella Retractor	71	BUZZ™ Non-stick Semken Bipolar Forceps	190	Distractor	28
Adson Dissecting Hook	172	BUZZ™ Non-stick Straight Bipolar Forceps	188	Dorsey Dura Separator	11
Adson Dura Hook	8	Caliper	30	Double Action Bone Rongeurs	81-85
Adson Elevator	17	Carbon Fiber Retractor Blades	32	Double Ducker Retractor	67
Adson Single Action Bone Rongeur	80	Caspar Intervertebral Disc Rongeur	94	Double Ended Dissector	14
Adson Suction Tubes	141	Cervical Bayonet Curettes	134	Double Ended Dura Separator	11
Anderson-Adson Cerebella Retractor	71	Cervical Bayonet Curettes, XL	135	Drill Guide	28
Anterior Cervical Fusion Distraction System	28-32	Cervical Vertebral Spreader	62	Drills	12-14
Anterior Cervical Fusion (ACF) Tray	31	Cloward Blade Retractor	61	Ducker Retractor	67
Apfelbaum Bipolar Bayonet Forceps ...	185	Cloward Intervertebral Disc Rongeur ..	91	Dura Dissectors	13-15
Apfelbaum Bipolar Forceps Tray	185	Cloward Lamina Spreader	62	Dura Elevators	13-16, 17-22
Apfelbaum Dissection Tray	154, 156	Cloward Style Depth Gauge	30	Dura Hooks	173
Apfelbaum Dissector Set	153, 156	Cloward Type Cervical Vertebral Spreader	62	Dura Knife	154, 156
Apfelbaum Extended Reach Curettes ..	128	Cobb Elevator	20, 22	Dura Separators	11-12, 16
Apfelbaum Micro Dissection Mirror ...	157	Cobb Spinal Elevator	22	Early Spinal Fusion Knife	7
Atraumatic Tip Suction Tubes	143	Cobb Style Bone Curettes	129	Echlin Double Action Bone Rongeur ...	84
Atraumatic Tip Suction Tubes with Multiple Holes	142	Cobb Type Gouge	25	Ejector Kerrisons	113-114
Bacon Rongeur	80	Cone Ring Curettes	132	Elevators	13-22, 151, 153, 155, 165, 170
Ball Dissector	152	Contour Scalp Retractor	64	Endonasal Pituitary Hook	9
Ballenger Septum Elevator	21	Cottle Septum Elevator	21	Endonasal Pituitary Instrument Set	213
Bar Ejector Kerrison	114	Cranial Burrs and Drills	2-4	Endonasal Suction Tubes	144
Bayonet Curettes	131, 133-146, 170	Crial Ganglion Knife	7	Endoscopic Endonasal Pituitary Instrument Set	213
Bayonet Cushing IVD Rongeurs	98	Cup Curette	161, 164	Enucleator	212
Bayonet Kerrisons	103	Curettes	119-136, 152, 154, 156, 161, 164, 166, 170, 211	Epstein Curettes	129
Bayonet Love-Gruenwald IVD Rongeurs	98	Curved Kerrisons	115-116	Evandro De Oliveira Micro Scissors.....	94
Bayonet Probe	161	Cushing Bipolar Forceps	180	Expanded Micro Dissection Instrument Tray	152
Bayonet Spurling IVD Rongeurs	98	Cushing Burr	2	Expanded Micro Dissection Set	150
Bayonet Suction Tubes	145	Cushing Decompression Retractor	58	Feler-Ducker Retractor	68
Beckman-Adson Retractor	72	Cushing Delicate Pattern Intervertebral Disc Rongeur	87	Fenestrated Iliac Blades, Ball Snap	30
Beckman-Eaton Retractor	72	Cushing Dura Hook	8	Ferris-Smith Kerrisons	112
Belluci Micro Alligator Scissors	206	Cushing Gasserian Ganglion Hook	10	Ferris-Smith Intervertebral Disc Rongeur	96
Beyer Double Action Bone Rongeur	84	Cushing Intervertebral Disc Rongeur ...	87	F-G Fukushima-Chen Cerebellar Pontine Tumor Bayonet Micro Dissectors	163-164
Beyer Rongeur	81	Cushing Little Joker	18	F-G Fukushima-Giannotta Skullbase and Micro Dissectors	159-162
Bipolar Cord	192	Cushing Perforating Drill	2	Flat handle Hartman Alligator Forceps..	207
Bipolar Forceps	180-192	Cushing Periosteal Elevator	18	Flat handled Gerald Forceps	178
Blade Ejector	30, 33, 34	Cushing Vein Retractor	58	Flatback Spinal Fusion Curettes	124-125
Blunt Blades	39	D'Errico Perforating Drill	3	Flexi-Spine™ Instrument Tray	36
Bone Curettes	129	Dandy Nerve Hook	10	Flexi-Spine™ Retraction System	36-37
Bone Cutters	78-79	Davis Nerve Separator and Spatula	13	Forceps	176-179, 215-217
Bone Graft Harvesting Forceps	31	Davis Scalp Retractor	64	Frazier Dura Hook	8
Bone Graft Holder	31	Davis Spatula	14, 53	Frazier Dura Separator	12
Bone Graft Impactor	31	DeBakey Forceps	177	Frazier Suction Tubes	138-140
Bone Rongeurs	80-85	Decker Intervertebral Disc Rongeur	96	Freer Double Ended Dissector	13
Bunnell Hand Drill, with Jacobs Chuck ...	4	Deeper Ducker Retractor	67	Freer Elevator	13
Burrs	12-13	Depth Gauge	36	Fukushima Transphenoidal Micro Ring Curettes	210
BUZZ™ Accessories	192	D'Errico Nerve Root Retractor	55	Fukushima-Giannotta Micro Bayonet	
BUZZ™ Lite™ Non-stick Bayonet Bipolar Forceps	192	DeVilbiss Cranial Rongeur	78	Needle Holders	198
BUZZ™ Non-stick Adson Bipolar Forceps	190	Diamond™ Kerrisons	101, 105, 109	Fukushima-Giannotta Micro Bayonet Scissors	198
BUZZ™ Non-stick Bayonet Bipolar Forceps	187	Diamond™ Medium Kerrisons	105	Fulton Double Action Bone Rongeur ...	85
BUZZ™ Non-stick Bipolar Forceps	187-192	Diamond™ Micro Kerrisons	101	Gardner-Wells Traction Tonge	76
BUZZ™ Non-stick Cushing Bipolar Forceps	188	Diamond™ Spurling Kerrisons	109		

Gerald Bipolar Bayonet Forceps	181	Leksell Double-Action Bone Rongeur ...	85	Micro Kerrisons	99-102
Gerzog Bone Mallet	24	Lempert Single Action Bone Rongeur....	80	Micro Lumbar Discectomy (MLD)	
Gigli Saw Blades	6	Ligature Guide	157	Retraction System.....	33
Gigli Saw Guide	6	Ligature Needle	174	Micro Needle Holders	48, 198, 200-203
Gigli Saw Handle	5	Ligature Passer	169	Micro Ring Forceps	176
Gouges	25	Liston Bone Cutting Forceps	79	Micro Scissors	193-198
Hand-Held Retractors	58-61	Long Bone Graft Impactor	26	Micro Serrated Bayonet Scissors	197
Hand-Held Silicone Retractors	51-52	Long Teeth Blades	37, 39	Micro Serrated Bayonet Scissors Tray..	197
Hardy Style Bipolar Bayonet Forceps ..	182	Longitudinal Retractor.....	29, 36, 38	Micro Tying Forceps	176
Hercules Triple Action Wire Cutter	86	Longitudinal Retractor Blades, Ball Snap		Micro-Angled Curettes	130
Hibbs Retractor	59	29	Micro-Bayonet Curettes	130
Hibbs Type Hemilaminectomy Blades	75	Love Bayonet Nerve Root Retractor.....	56	Microsurgical Bayonet Handle Hook ...	174
Hingeless Curved Kerrison	116	Love Nerve Root Retractor.....	56	Microsurgical Bipolar Bayonet Forceps	
Hoehn Dura Separator	11	Love-Adson Elevator.....	17	181
Hoehn Nerve Hook	10	Love-Gruenwald Delicate Pattern		Microsurgical Curettes	130-131
Hoehn Periosteal Elevator	20	Intervertebral Disc Rongeur	88	Miskimon Cerebellum Retractor	70
Hoehn Retractor	69	Love-Gruenwald Intervertebral		M-Jensen Bipolar Forceps	186
Holscher Nerve Root Retractor	56	Disc Rongeur	48, 88	MLD Center Retractor Blades, Ball Snap ...	
Hooks ... 8-10, 37, 39, 50, 159, 166, 173-174		Lumbar and Cervical Impactor.....	26	33
Horsley Dura Separator and Guard	12	Lumbar Bayonet Curettes	136	MLD Retractor.....	33
Hudson Brace	4	LumbarTrak™ Blade Popper.....	41	Mounting Arm	45
Hudson Burr	2	LumbarTrak™ Handle	41	Mounting Rod Clamp	45
Hudson Cranial Drill Set	4	LumbarTrak™ Hook	43	Mouth Gag	47
Hudson Extension	3	LumbarTrak™ Long Connector	41	M-Style Bipolar Forceps	186
Impactors.....	26	LumbarTrak™ Medium Blades	42	Multi-Hole Suction Tubes	142
Improved Cervical Lamina Spreader	62	LumbarTrak™ Quick Connector	41	Multiple-Toothed Hooks	50
Inge Lamina Spreader	63	LumbarTrak™ Retractor System	40-43	Murphy Ball Hook	10
Intervertebral Disc Rongeur	87-98	LumbarTrak™ Sacral Blade	43	Nagel Micro Scissors.....	194
Iris Bipolar Straight Forceps	180	LumbarTrak™ Scoville Retractor	40	Narrow Muscle Blade	50
IVD Rongeurs	87-98	LumbarTrak™ Square Retractor	40	Nasal Scissors	204
Jackson Intervertebral Disc Rongeur	95	LumbarTrak™ Thin Blades	42	Needle.....	166
Jacobson Micro Bayonet Needle Holder		LumbarTrak™ Titanium Depth Gauge .	41	Needle Dissector.....	152
.....	200	LumbarTrak™ Tray	43	Needle Holders	48, 198, 200-203
Jacobson Micro Bayonet Scissors	195	LumbarTrak™ Wide Blades	42	Nerve Hook	169, 174
Jacobson Micro Needle Holder.....	200	Markham-Meyerding Retractor	66	Nerve Root Retractors	55-57
Jacobson Probe	158	Martin Nerve Root Retractor	55	Non-stick Bipolar Forceps	187-192
Jacobson Scissors	193	McCravey Tissue Forceps.....	177	Oberhill Retractor	72
Jacobson Suture Pusher.....	158	McCulloch Retractor	49	Oldberg Dissector	16
Jacobson Vessel Knife	157	McCulloch Retractor Tray	49	Olivecrona Alligator Scissors	204
Janetta Double Round Bar	65	McKenzie Enlarging Burr	3	Olivecrona Double Ended Dissector	13
Janetta Malleable Blades	65	McKenzie Perforating Drill	3	Open-Handle Kerrison	11
Janetta Retractor Body.....	65	Medial Retractor Blades, Ball Snap	29	Optional Blades (pair)	39
Janetta Retractor Set	65	Medium Kerrisons	104-106	Osteotomes	23-24
Jansen Deep Blade Scalp Retractor	64	Meyerding Retractor	59, 66	Oval Curette	166
Jansen Scalp Retractor.....	64	Meyerding Type Hemilaminectomy		Oval Ring Curette	132
Jeweler's Bipolar Forceps	180	Blades	74	Packers	16
John Day Periosteal Elevator	21	Micro Alligator Grasping Forceps		Paine's Carpal Tunnel Retinaculotome	7
Joseph Periosteal Elevator.....	19	and Scissors	205	Palate Retractor	46
Kerrison Instrument Tray	117	Micro Arachnoidea Knife	175	Palate Retractor Clamp.....	47
Key Periosteal Elevator.....	19	Micro Bayonet Needle Holders		Peapod Intervertebral Disc Rongeur.....	92
Killian Septum Speculum	208	48, 198, 200-203	Penfield Dura Dissector.....	15
Knives	7, 17, 159, 160, 163, 175, 209	Micro Bayonet Scissors	195	Periosteal Instruments.....	16
Knife Handle	212	Micro Cup Forceps	206	Pin Ejector Kerrison	113
Krayenbuhl Hook	172	Micro Curette.....	152	Polishing Cloth.....	192
Kurze Dissecting Scissors	204	Micro Curved Kerrison	115	Poppen Intervertebral Disc Rongeur	89
Lahey Clinic Dura Hook	9	Micro Disc Rongeur	95	Poppen Suction Tubes	141
Lambotte Osteotome.....	23	Micro Dissection Instrument Tray.....	152	Potts-Smith Dressing Forceps.....	178
Lamina Spreaders.....	62-63	Micro Dissection Set Components		Presbyterian Hospital Staphylorrhaphy	
Langenbeck Periosteal Elevator	20	150-152, 157, 158	Elevator	14
Lateral Retractor	46	Micro Ejector Kerrisons	113-114	Probes.....	160, 162, 163, 166
Lateral Retractor Blades, Ball Snap	30	Micro Forceps	176-179	Raney Clip Applying Forceps	207
Lateral Retractor Clamp	47	Micro Hook	174	Raney Saw Guide.....	6

Raspatory.....	157-158	Smith-Peterson Double Action Bone Rongeur	82	Thoraco-Lumbar Curettes	128
Reflective Spheres.....	214	Smith-Peterson Gouge.....	25	Thoraco-Lumbar Dissectors	128
Retinaculum.....	17	Smith-Peterson Osteotome	24	Tip Protectors	214
Retractor Blade Handle.....	37-38	Smithwick Button Hook.....	10	Titanium Bayonet Needle Holder With Lock	203
Rhoton Bipolar Forceps	181	Snitman Retractor.....	64	Titanium Bayonet Scissors	199
Rhoton Style Micro Scissors.....	194	Spatula Dissector.....	151, 153, 155, 165	Titanium Biopsy Needle	171
Right Angle Hook.....	151, 154, 156	Spatulas.....	51-54, 151, 153, 155, 165	Titanium Bipolar Bayonet Forceps ..	84-185
Ring Curette.....	161, 164	Speculum Retractor.....	33	Titanium Dissection Instruments ..	169-171
Ring Curettes.....	132, 211	Speculums	208	Titanium Forceps	177
Ring Handled Forceps and Scissors	204-207	Spetzler Sonntag Trans-Oral Instruments Set	48	Titanium Gardner-Wells Traction Tongs..	76
Ring Handled Microsurgical Forceps	205	Spetzler Sonntag Trans-Oral Retractor	44-47	Titanium Round Handled Bayonet Needle Holder	203
Ring Handled Microsurgical Scissors	205	System	44-47	Titanium Round Handled Bayonet Scissors	199
Round Bayonet Handle Micro Curettes	131	Spinal Curettes	120-128	Titanium Round Handled Straight Scissors.....	199
Round Dissector	151, 153, 155, 170	Spinal Fusion Curette Tray	123, 126, 133	Titanium Scissors	199
Round Handled Rhoton Style Instruments.....	165-166	Spinal Fusion Curettes.....	120-126, 132	Tongue Depressor	46
Round Knife.....	163	Spinal Retraction System.....	38-39	Traction Tongs	76
Ruggles Retinaculotome.....	7	Spinal Retractor System Tray.....	38	Trans-oral Retractor Tray	47
RUGGLES™ Speculum.....	208	Spurling Delicate Pattern Intervertebral Disc Rongeur	90	Transphenoidal Curette Tray	211
Ruskin Double Action Bone Rongeur	83	Spurling Ejector Kerrisons	114	Transphenoidal Hypophysectomy Bipolar Bayonet Forceps	181
Ruskin Rongeur	83	Spurling Intervertebral Disc Rongeur	90-91	Transphenoidal Instruments	209-212
Ruskin-Liston Bone Cutting Rongeur.....	78	Spurling Kerrisons.....	107-111	Transphenoidal Speculum	208
Ruskin-Rowland Bone Cutting Forceps ..	79	Stealth™ Ferris Smith Kerrisons.....	112	Transverse Retractor	29, 36, 38
Sachs Dura Hook.....	8	Stealth™ Hingeless Curved Kerrisons	116	Trays.....	31, 36, 38, 43, 47-49, 117, 123, 126, 133, 152, 154, 156, 185, 192, 197, 211
Sachs Dura Separator	12	Stealth™ Kerrisons	100, 104, 108, 112, 113, 116	Triple Action Wire Cutter	86
Sachs Dura Separator and Guard.....	11	Stealth™ Medium Kerrisons	104	Twist Drill	28
Sachs Nerve Root Separator	12	Stealth™ Micro Ejector Kerrisons.....	113	Ultra-Coat™ Curettes	120-121
Sachs Nerve Separator and Spatula.....	14	Stealth™ Micro Kerrisons	100	Ultra-Coat™ Bayonet Cushing IVD Rongeurs	97
Sachs Vein Retractors.....	60	Stealth™ Spurling Kerrisons	108	Ultra-Coat™ Bayonet Ejector Kerrison Micro	103
Saws.....	5-6	Stille Double Action Bone Rongeur.....	81	Ultra-Coat™ Bayonet Kerrison Micro	103
Semmes Spinal Fusion Curettes	132	Stille-Echlin Double Action Bone Rongeur	81	Ultra-Coat™ Bayonet Love-Gruenwald IVD Rongeurs	97
Scalp Retractors	64	Stille-Horsley Bone Cutting Rongeur	78	Ultra-Coat™ Bayonet Spurling IVD Rongeurs	97
Scissors.....	193-198	Stille-Liston Bone Cutting Rongeur.....	78	Ultra-Coat™ Flatback Curettes	125
Scoville Haverfield Type Hemilaminectomy Retractor Body.....	73	Stille-Luer Double Action Bone Rongeur....	82	Ultra-Coat™ Kerrisons....	99, 103, 107, 113
Scoville Nerve Root Retractor.....	55	Stille-Luer Duckbill Double Action Bone Rongeur	82	Ultra-Coat™ Micro Ejector Kerrisons	113
Scoville Ruptured Disc Curettes.....	127	Stylet for BUZZ™ Bipolar Forceps.....	192	Ultra-Coat™ Micro Kerrisons	99
Scoville Type Hemilaminectomy Blades..	74	Stookey Single Action Bone Rongeur....	80	Ultra-Coat™ Spinal Curettes	120-121
Scoville Type Hemilaminectomy Hook Blades	73	Strully Dura Twist Hook	9	Ultra-Coat™ Spurling Kerrisons	107
Scoville Type Hemilaminectomy Retractor Body.....	73	Strully-Gigli Saw Handle	5	UMLD Hooks, Ball Snap	35
Scoville-Green Style Bipolar Bayonet Forceps.....	183	Suction Nerve Retractor	57	UMLD Retractor Blades	34
Screwdriver	28	Super Master Wire Cutter	86	UMLD Scoville Blades, Ball Snap	35
Sedillot Elevator	20	Swivel Knife	86	UMLD Scoville Retractor	34
Self-Retaining Retractors.....	65-75	T. Fukushima Dura Spatula	54	UMLD Taylor Blades, Ball Snap	35
Seltz-Gelpi Retractor	66	T. Fukushima Dural Elevator and Spatula....	22	UMLD T-Bars, Ball Snap	35
Semken Bipolar Straight Forceps.....	180	T. Fukushima Periosteal Elevator	21	Universal Micro Lumbar Discectomy	(UMLD) Retraction System.....
Semken Forceps	179	T. Fukushima Spatula	54	US Army Retractor	59
Semmes Spinal Fusion Curettes	132	T. Fukushima Tapered Teardrop Suction Tubes	147	Vertebral Body Dissector	31
Senn Retractor	58	Table Clamp.....	45	Vessel Supporter	169
Separators.....	11-13, 26, 160	Tapered Teardrop Suction Tubes	146-148	Vinyl Tip Protectors	214
Septal Breaker.....	207	Taylor Spinal Retractor	61	Volkman Retractor	58
Short Teeth Blades	37, 39, 67, 68	Taylor Type Hemilaminectomy Blades ...	75		
Silicone Retractors	51-52	Teardrop Dissector	154, 156		
Silicone Spatulas	61-62				
Single Action Bone Rongeur.....	80				
Sisco Bayonet Curettes	113				
Slotted Tongue Depressor	46				

Weary Nerve Hook	173
Weil-Blakesley Forceps	206
Weitlaner Angled Self-Retaining Retractor	70
Weitlaner Hinged Self-Retaining Retractor	70
Weitlaner Self-Retaining Retractor	69
Wide Muscle Blade	50
Wilde Intervertebral Disc Rongeur...	92-93
Williams Style Discectomy Retractor	68
Williams Style Micro Disc IVD	95
Wiltse-Gelpi Retractor	66
Wire Cutter	86
Woodson Double Ended Packer	16
Woodson Dura Separator and Packer .	16
Woodson Elevator	16
Woodson Elevator and Spatula	16
Yasargil Bayonet Forceps	179
Yasargil Bayonet Forceps (new style) ...	178
Yasargil Bayonet Tumor Forceps	179
Yasargil Ligature Carrier	175
Yasargil Micro Bayonet Needle Holder	202
Yasargil Micro Bayonet Scissors	195
Yasargil Micro Dissector	167-168
Yasargil Micro Scissors (new style)	196
Yasargil Scissors	194
Yasargil Style Bipolar Bayonet Forceps	183
Zaufal-Jansen Double Action Bone Rongeur	84

651301.....	169	NI5SA03.....	191	NHAD04.....	189	R0176.....	13
651302.....	169	NI5SA10.....	191	NHAD05.....	189	R0177.....	13
651303.....	169	NI5SA20.....	191	NHAD07.....	189	R0178.....	13
651304.....	169	NI7BL03.....	192	NHAD10.....	189	R0200.....	8
651305.....	169	NI7BL06.....	192	NHAD13.....	189	R0205.....	8
651306.....	170	NI7BL13.....	192	NHAD15.....	189	R0210.....	8
651307.....	170	NI7BL17.....	192	NHAD17.....	189	R0212.....	9
651308.....	170	NI8BS03.....	187	NHAD20.....	189	R0215.....	9
651309.....	170	NI8BS06.....	187	NHAU02.....	189	R0225.....	11
651310.....	170	NI8BS10.....	187	NHAU04.....	189	R0231.....	11
651311.....	170	NI8BS20.....	187	NHAU05.....	189	R0233.....	11
651312.....	170	NI8S03.....	191	NHAU07.....	189	R0235.....	11
651313.....	170	NI8S06.....	191	NHAU10.....	189	R0236.....	11
651365.....	199	NI8S10.....	191	NHAU13.....	189	R0240.....	13
651366.....	199	NI8SA03.....	191	NHAU15.....	189	R0243.....	13
651367.....	199	NI8SA06.....	191	NHAU17.....	189	R0244.....	13
651368.....	199	NI8SA10.....	191	NHAU20.....	189	R0245.....	14
651369.....	199	NI9C07.....	188	NH110.....	189	R0246.....	14
651370.....	199	NI9C12.....	188	NH115.....	189	R0247.....	14
651371.....	199	NI9C15.....	188	NI20SG20.....	188	R0248.....	12
651375.....	199	N20BAD10.....	187	NI15BS10.....	187	R0250.....	7
651376.....	199	N20BAU10.....	187	NI18BS06.....	187	R0252.....	14
651377.....	199	N20BS03.....	187	NI19C07.....	188	R0256.....	18
651378.....	199	N20BS06.....	187	NI19C15.....	188	R0259.....	14
651388.....	203	N20BS10.....	187	NI20SG10.....	188	R0260.....	17
651389.....	203	N20BS20.....	187	NI20SG15.....	188	R0261.....	17
651390.....	203	N20S03.....	191	NI22BS06.....	187	R0262.....	17
651394.....	203	N20S10.....	191	NI22BS10.....	187	R0263.....	17
651395.....	203	N20S20.....	191	NI22BS20.....	187	R0265.....	16
651600.....	171	N20SA03.....	191	NL7702701.....	51	R0267.....	16
651601.....	171	N20SA10.....	191	NL7702702.....	51	R0268.....	16
651605.....	171	N20SA20.....	191	NL7702703.....	51	R0269.....	19
BUZZSTYLET.....	192	N20SG15.....	188	NL7702704.....	51	R0270.....	19
NI0BL03.....	192	N22BAD10.....	187	NL7702705.....	51	R0271.....	19
NI0BL06.....	192	N22BAU10.....	187	NL7702707.....	51	R0272.....	19
NI0BL13.....	192	N22BS03.....	187	NL7702708.....	51	R0273.....	19
NI0BL17.....	192	N22BS06.....	187	NL8700200.....	51	R0274.....	19
NI1J06.....	190	N22BS10.....	187	NL8700204.....	51	R0275.....	19
NI1J025.....	190	N22BS20.....	187	NL8700206.....	51	R0276.....	19
NI1J10.....	190	N22S03.....	191	NL8700208.....	51	R0277.....	20
NI25A07.....	190	N22S10.....	191	NL8700210.....	51	R0278.....	20
NI25A12.....	190	N22S20.....	191	NL8700214.....	51	R0279.....	20
NI3BL03.....	192	N22SA03.....	191	NRBC118.....	192	R0280.....	20
NI3BL06.....	192	N22SA10.....	191	R0010.....	2	R0281.....	20
NI3BL13.....	192	N22SA20.....	191	R0015.....	2	R0285.....	18
NI3BL17.....	192	N24BS03.....	187	R0020.....	2	R0286.....	18
NI3BLA15.....	192	N24BS06.....	187	R0025.....	2	R0287.....	20
NI3BLA30.....	192	N24BS10.....	187	R0030.....	2	R0289.....	18
NI3BLA45.....	192	N24BS20.....	187	R0035.....	2	R0290.....	18
NI5BL03.....	192	NBCLOTH.....	192	R0040.....	2	R0291.....	18
NI5BL06.....	192	NBT10.....	192	R0041.....	2	R0294.....	22
NI5BL13.....	192	NBT35.....	192	R0042.....	2	R0295.....	17
NI5BL17.....	192	NH02.....	189	R0043.....	2	R0296.....	22
NI5BS03.....	187	NH04.....	189	R0060.....	3	R0297.....	22
NI5BS06.....	187	NH05.....	189	R0065.....	3	R0298.....	22
NI5BS10.....	187	NH07.....	189	R0070.....	3	R0299.....	22
NI5BS20.....	187	NH10.....	189	R0075.....	4	R0300.....	24
NI5S03.....	191	NH13.....	189	R0076.....	4	R0301.....	24
NI5S06.....	191	NH15.....	189	R0080.....	3	R0302.....	24
NI5S10.....	191	NH17.....	189	R0085.....	4	R0303.....	24
NI5S12.....	190	NH20.....	189	R0088.....	4	R0304.....	24
NI5S20.....	191	NHAD02.....	189	R0175.....	13	R0305.....	24

R0306.....	24	R0785	141	R1135	75	R1273	66
R0310.....	24	R0786	141	R1136	75	R1275	66
R0311.....	24	R0787	141	R1137	75	R1280	66
R0312.....	24	R0788	141	R1138	75	R1285	66
R0313.....	24	R0789	141	R1139	75	R1290	66
R0314.....	24	R0790	141	R1140	75	R1297	58
R0315.....	24	R0791	141	R1142	75	R1298	58
R0316.....	24	R0845	172	R1143	75	R1300	78
R0360B.....	122	R0848	10	R1144	75	R1305	78
R0361B.....	122	R0860	10	R1145	75	R1306	78
R0362B.....	122	R0861	10	R1146	75	R1307	78
R0363B.....	122	R0862	10	R1147	75	R1310	78
R0364B.....	122	R0924	53	R1148	75	R1312	78
R0365B.....	122	R0924A	53	R1149	75	R1320	80
R0366B.....	122	R0925	53	R1150	64	R1324	80
R0367B.....	122	R0925A	53	R1151	64	R1325	80
R0368B.....	122	R0926	53	R1155	64	R1326	80
R0435.....	178	R0926A	53	R1160	64	R1327	80
R0437.....	178	R0927	53	R1165	72	R1330	80
R0439.....	178	R0927A	53	R1166	72	R1338	83
R0440.....	178	R0928	53	R1170	72	R1339	83
R0442.....	178	R0928A	53	R1175	72	R1340	83
R0455.....	177	R0929	53	R1189	71	R1341	83
R0462.....	177	R0929A	53	R1190	71	R1342	83
R0506.....	207	R0930	53	R1194	71	R1343	83
R0515.....	7	R0930A	53	R1195	71	R1344	83
R0520	7	R1000	55	R1197	71	R1350	84
R0521	7	R1005	55	R1200	69	R1355	84
R0658	141	R1007	55	R1201	69	R1370	84
R0659	141	R1024	56	R1205	69	R1375	84
R0660	141	R1025	56	R1206	69	R1380	84
R0661	141	R1026	56	R1208	70	R1381	82
R0662	141	R1027	56	R1209	70	R1382	82
R0663	141	R1050	62	R1210	69	R1383	82
R0664	141	R1054	62	R1211	69	R1385	81
R0674	142	R1060	61	R1215	69	R1386	82
R0675	142	R1061	61	R1216	69	R1387	82
R0676	142	R1062	61	R12164	26	R1388	82
R0677	142	R1070	63	R12165	26	R1390	85
R0678	142	R1075	63	R12166	26	R1391	85
R0679	142	R1093	59	R12167	26	R1392	85
R0680	142	R1095	58	R12168	26	R1470	81
R0681	142	R1096	59	R12169	26	R1475	81
R0682	142	R1100	58	R1217	70	R1480	81
R0707	140	R1106	73	R12170	26	R1587	111
R0708	140	R1111	73	R12171	26	R1591	111
R0710	140	R1113	73	R1218	70	R1593	111
R0711	140	R1114	73	R1220	69	R1596	111
R0712	140	R1115	73	R1221	69	R1635	114
R0713	140	R1116	73	R1225	70	R1636	114
R0714	140	R1118	74	R1226	70	R1637	114
R0715	140	R1119	74	R1230	70	R1638	114
R0716	140	R1120	74	R1231	70	R16403	114
R0770	140	R1121	74	R1233	58	R16404	114
R0771	140	R1123	74	R1234	58	R16405	114
R0772	140	R1124	74	R1235	58	R16702	115
R0773	140	R1126	74	R1236	58	R16703	115
R0774	140	R1127	74	R1237	58	R16703L	115
R0775	140	R1128	74	R1238	58	R16703R	115
R0776	140	R1130	75	R1239	58	R16704	115
R0777	140	R1131	75	R1240	58	R16705	115
R0778	140	R1134	75	R1272	66	R16706	115

R1711	93	R2006	126	R2646	180	R2871	133
R1711L	93	R2007	126	R2691	184	R2872	133
R1712	93	R2008	126	R2692	184	R2873	133
R1712L	93	R2010	126	R2693	184	R2874	133
R1713	93	R2011	126	R2694	184	R2875	133
R1713L	93	R2012	126	R2696	181	R2876	133
R1714	93	R2013	126	R2697	181	R2877	133
R1714L	93	R2014	126	R2698	181	R2878	133
R1716	93	R2015	126	R2799	124	R2881	133
R1716L	93	R2016	126	R2800	48,124	R2882	133
R1717	93	R2017	126	R2801	48,124	R2883	133
R1717L	93	R2018	126	R2802	124	R2884	133
R1718	93	R2200	23	R2803	124	R2885	133
R1718L	93	R2201	23	R2804	124	R2886	133
R1719	93	R2202	23	R2805	124	R2891	133
R1719L	93	R2203	23	R2806	124	R2892	133
R1722	92	R2204	23	R2807	124	R2893	133
R1723	92	R2205	23	R2808	124	R2894	133
R1724	92	R2210	23	R2809	124	R2895	133
R1745	95	R2211	23	R2810	124	R2896	133
R1758	91	R2212	23	R2819	124	R3320	86
R1759	91	R2213	23	R2820	48,124	R3321	86
R1765	89	R2214	23	R2821	48,124	R3325	86
R1766	89	R2215	23	R2822	124	R5501	214
R1767	89	R2220	129	R2823	124	R5502	214
R1785	89	R2221	129	R2824	124	R5503	214
R1786	89	R2222	129	R2825	124	R5504	214
R1787	89	R2223	129	R2826	124	R5505	214
R1790	91	R2224	129	R2827	124	R5506	214
R1791	91	R2225	129	R2828	124	R5507	214
R1792	91	R2226	129	R2829	124	R5508	214
R18045	89	R2227	129	R2830	124	R5509	214
R18055	89	R2228	129	R2839	124	R6000	28
R18065	89	R2230	129	R2840	48,124	R6298	31
R18165	89	R2231	129	R2841	48,124	R6310	30, 33-34
R18175	89	R2232	129	R2842	124	R6312	29
R18185	89	R2233	129	R2843	124	R6313	29
R18402	94	R2234	129	R2844	124	R6314	31
R18403	94	R2235	129	R2845	124	R6315	31
R18404	94	R2236	129	R2846	124	R6316	31
R18405	94	R2237	129	R2847	124	R6317	30
R18453	94	R2238	129	R2848	124	R6318	31
R18454	94	R2240	25	R2849	124	R6319	31
R18455	94	R2241	25	R2850	124	R6320	30
R18503	94	R2242	25	R2851	124	R6321	30
R18504	94	R2243	25	R2852	124	R6322	57
R18615	89	R2260	25	R2853	124	R6323	57
R18625	89	R2261	25	R2854	124	R6324	57
R18635	89	R2262	25	R2855	124	R6337	31
R1925	204	R2263	25	R2856	124	R6367A	28
R1942	76	R2264	25	R2857	124	R6370	29
R1944	76	R2265	25	R2858	124	R6371	29
R1944TS	76	R2266	25	R2859	124	R6372	29
R1945	76	R2270	25	R2860	133	R6373	29
R1946	76	R2271	25	R2861	133	R6374	29
R1947	76	R2272	25	R2862	133	R6375	30
R1949	76	R2273	25	R2863	133	R6376	30
R2000	126	R2274	25	R2864	133	R6377	30
R2001	126	R2275	25	R2865	133	R6378	30
R2002	126	R2276	25	R2866	133	R6379	30
R2003	126	R2620	181	R2867	133	R6381	29
R2004	126	R2640	180	R2868	133	R6382	29
R2005	126	R2645	180	R2870	133	R6383	29

R6384	29	R6561	30	R7352	131	R8860	205
R6385	29	R6562	30	R7353	131	R8861	205
R6387	28	R6563	30	R7360	131	R8862	205
R6388	28	R6564	30	R7361	131	R8865	210
R6389	28	R6579	34	R7362	131	R8866	210
R6390	31	R6601	34	R7363	131	R8867	210
R6391	31	R6602	34	R7365	131	R8868	210
R6392	28	R6603	34	R7366	131	R8869	210
R6393	28	R6604	34	R7367	131	R8870	210
R6394	28	R6621	35	R7368	131	R8871	210
R6396	28	R6622	35	R7370	131	R8872	210
R6397A	28	R6623	35	R7371	131	R8873	210
R6398A	28	R6624	35	R7372	131	R8874	210
R6399	31	R6630	34	R7373	131	R8875	210
R6405	33	R6631	34	R7401	208	R8876	163
R6406	33	R6632	34	R7402	208	R8877	163
R6407	33	R6633	34	R7403	208	R8878	163
R6408	33	R6640	35	R8113	123, 133	R8879	163
R6409	33	R6641	35	R8114	123, 133	R8880	163
R6410	33	R6642	35	R8210	201	R8881	163
R6411	33	R6643	35	R8230	176	R8882	164
R6412	33	R6644	35	R8231	176	R8883	164
R6413	33	R7250	68	R8234	173	R8884	164
R6414	33	R7251	68	R8235	173	R8885	164
R6415	33	R7252	68	R8250	176	R8886	164
R6416	33	R7253	68	R8251	176	R8887	163
R6417	33	R7254	68	R8312	193	R8888	163
R6418	33	R7255	68	R8401	157	R8889	164
R6506	128	R7260	68	R8402	157	R8890	164
R6507	128	R7261	68	R8403	157	R8891	164
R6510	128	R7262	68	R8408	157	R8906	21
R6511	128	R7263	68	R8409	157	R8907	21
R6512	128	R7264	68	R8410	157	R8908	21
R6513	128	R7265	68	R8411	158	R8909	21
R6514	128	R7305	174	R8412	158	R8911	22
R6515	128	R7306	174	R8413	158	R8912	22
R6516	128	R7307	174	R8414	158	R8913	21
R6517	128	R7308	174	R8415	158	R8914	21
R6518	128	R7309	174	R8416	158	R8915	21
R6519	128	R7310	174	R8445	175	R8924	198
R6520	128	R7315	174	R8520	209	R8925	198
R6521	128	R7316	174	R8521	209	R8926	198
R6523	126	R7317	174	R8522	209	R8927	198
R6540	26	R7318	174	R8525	209	R8928	198
R6541	26	R7320	174	R8526	209	R8929	198
R6542	26	R7321	174	R8527	209	R8930	198
R6543	26	R7330	165	R8530	209	R8931	198
R6544	26	R7331	165	R8535	208	R8931S	198
R6545	26	R7332	165	R8536	208	R8932	198
R6546	26	R7333	165	R8537	208	R8933	198
R6547	26	R7334	165	R8538	208	R8934	198
R6548	26	R7335	165	R8645	205	R8935	159
R6550	29	R7336	165	R8646	205	R8936	159
R6551	29	R7337	165	R8647	205	R8937	159
R6552	29	R7338	166	R8658	206	R8938	159
R6553	29	R7339	166	R8659	206	R8939	159
R6554	29	R7340	166	R8850	205	R8940	159
R6555	29	R7341	166	R8851	205	R8941	159
R6556	29	R7342	166	R8852	205	R8942	160
R6557	29	R7343	166	R8855	205	R8943	160
R6558	29	R7344	166	R8856	205	R8944	160
R6559	29	R7350	131	R8857	205	R8945	160
R6560	30	R7351	131	R8858	205	R8946	161

R8947	161	R9000	147	RB1468	23	RB2142	50
R8948	161	R9000SM	148	RB1469	23	RB2143	50
R8949	161	R9001	147	RB1470	23	RB2144	50
R8950	161	R9001SM	148	RB1471	23	RB2145	50
R8951	161	R9002	147	RB1472	23	RB2147	50
R8952	161	R9002SM	148	RB1473	23	RB2148	50
R8953	161	R9003	147	RB1474	23	RB2149	50
R8954	160	R9004	147	RB1475	23	RB2150	50
R8955	160	R9005	147	RB1476	23	RB2151	50
R8956	162	R9006	147	RB1477	23	RB2152	50
R8958	162	R9007	147	RB1478	23	RB2218	60
R8959	54	R9007SM	148	RB1479	23	RB2219	60
R8960	54	R9008	147	RB1480	23	RB2220	60
R8961	54	R9008SM	148	RB1481	23	RB2252	72
R8962	54	R9009	147	RB1482	23	RB2286	66
R8963	54	R9009SM	148	RB1483	23	RB2304	61
R8964	54	R9010	147	RB1484	23	RB2305	61
R8965	147	R9012SM	148	RB1485	23	RB2306	61
R8966	147	R9013SM	148	RB1486	23	RB2308	62
R8967	147	R9014SM	148	RB1487	23	RB2375	30
R8968	147	R9015SM	148	RB1488	23	RB2470	32
R8969	147	R9016SM	148	RB1489	23	RB2471	32
R8970	147	R9017SM	148	RB1490	23	RB2472	32
R8977	159, 161	R9018SM	148	RB1491	23	RB2473	32
R8979	54	R9019SM	148	RB1492	23	RB2474	32
R8980	147	R9020SM	148	RB1543	20	RB2475	32
R8980SM	148	R9021SM	148	RB1544	20	RB2480	32
R8981	147	R9042	147	RB1545	20	RB2481	32
R8981SM	148	R9042SM	148	RB1546	20	RB2482	32
R8982	147	R9043	147	RB1547	20	RB2483	32
R8982SM	148	R9043SM	148	RB1695	24	RB2484	32
R8983	147	R9044	147	RB2002	80	RB2485	32
R8983SM	148	R9044SM	148	RB2003	81	RB2490	32
R8984	147	R9045	147	RB2014	83	RB2491	32
R8984SM	148	R9045SM	148	RB2015	83	RB2492	32
R8985	147	R9046	147	RB2044	81	RB2493	32
R8985SM	148	R9046SM	148	RB2047	83	RB2494	32
R8986	147	R9047	147	RB2054	79	RB2495	32
R8986SM	148	R9047SM	148	RB2055	79	RB2549	64
R8987	147	R9395	28	RB2064	79	RB2600	40
R8987SM	148	RB1063	6	RB2065	79	RB2601B	40
R8988	147	RB1109	10	RB2066	79	RB2602	40
R8988SM	148	RB1110	10	RB2067	79	RB2603	41
R8989	147	RB1150T	177	RB2068	79	RB2604	41
R8989SM	148	RB1154T	177	RB2069	79	RB2605	41
R8990	147	RB1174T	177	RB2070	79	RB2606	41
R8990SM	148	RB1175T	177	RB2071	79	RB2609	41
R8991	147	RB1322	12	RB2120	49	RB2610	42
R8991SM	148	RB1453	23	RB2121	49	RB2611	42
R8992	147	RB1454	23	RB2122	50	RB2612	42
R8992SM	148	RB1455	23	RB2123	50	RB2613	42
R8993	147	RB1456	23	RB2124	50	RB2614	42
R8993SM	148	RB1457	23	RB2125	50	RB2615	42
R8994	147	RB1458	23	RB2126	50	RB2616	42
R8994SM	148	RB1459	23	RB2127	50	RB2617	42
R8995	147	RB1460	23	RB2128	50	RB2618	42
R8995SM	148	RB1461	23	RB2129	50	RB2620	42
R8996	147	RB1462	23	RB2130	50	RB2621	42
R8996SM	148	RB1463	23	RB2131	50	RB2622	42
R8997	147	RB1464	23	RB2132	50	RB2623	42
R8997SM	148	RB1465	23	RB2133	50	RB2624	42
R8998	54	RB1466	23	RB2140	50	RB2625	42
R8999	54	RB1467	23	RB2141	50	RB2626	42

RB2627	42	RB41152	100	RB4861	100	RB5761	99
RB2628	42	RB41153	100	RB4862	100	RB5762	99
RB2629	42	RB41154	100	RB4863	100	RB5763X	99
RB2630	42	RB41155	100	RB4864	100	RB5764X	99
RB2631	42	RB41156	100	RB4865	100	RB5765	99
RB2632	42	RB41191	100	RB4866	100	RB5766	99
RB2633	42	RB4719	112	RB4872	100	RB5772	107
RB2640	43	RB4720	112	RB4872D	116	RB5773	107
RB2641	43	RB4721M	104	RB4873D	116	RB5774	107
RB2642	43	RB4722	108	RB4874D	116	RB5775	107
RB2643	43	RB4722M	104	RB4875D	116	RB5776	107
RB2644	43	RB4723	108	RB4882	100	RB5860	99
RB2645	43	RB4723M	104	RB4890	100	RB5861	99
RB2646	43	RB4724	108	RB4891	100	RB5862	99
RB2647	43	RB4724M	104	RB4892	100	RB5863	99
RB2648	43	RB4725	108	RB4892E	113	RB5864	99
RB2656	48	RB4725M	104	RB4893	113	RB5865	99
RB2657	48	RB4726	108	RB4894	113	RB5866	99
RB2658	48	RB4726M	104	RB4895	113	RB5872	107
RB2659	48	RB4751	100	RB4896	113	RB5873	107
RB2660	44	RB4751M	104	RB4922	108	RB5874	107
RB2661	45	RB4752	100	RB4923	108	RB5875	107
RB2662	45	RB4753	100	RB4924	108	RB5876	107
RB2663	45	RB4754	100	RB4925	108	RB5882	113
RB2664	45	RB4755	100	RB4926	108	RB5883	113
RB2665	46	RB4756	100	RB4951	100	RB5884	113
RB2666	46	RB4771	100	RB4952	100	RB5885	113
RB2667	46	RB4802	108	RB4953	100	RB5960	99
RB2668	46	RB4803	108	RB4954	100	RB5961	99
RB2669	46	RB4804	108	RB4955	100	RB5962	99
RB2670	46	RB4805	108	RB4956	100	RB5963	99
RB2671	47	RB4806	108	RB4991	100	RB5964	99
RB2672	46	RB4812	108	RB5062	99	RB5965	99
RB2673	46	RB4813	108	RB5063	99	RB5966	99
RB2674	46	RB4814	108	RB5064	99	RB5972	107
RB2675	46	RB4815	108	RB5065	99	RB5973	107
RB2676	46	RB4816	108	RB5066	99	RB5974	107
RB2677	46	RB4821M	104	RB5072	107	RB5975	107
RB2678	46	RB4822	108	RB5073	107	RB5976	107
RB2679	47	RB4822M	104	RB5074	107	RB6007	92
RB2680	47	RB4823	108	RB5075	107	RB6011	92
RB2690	48	RB4823M	104	RB5076	107	RB6012	92
RB3892	112	RB4824	108	RB5162	99	RB6013	92
RB3894	112	RB4824M	104	RB5163	99	RB6014	92
RB3895	112	RB4825	108	RB5164	99	RB6126	92
RB41022	108	RB4825M	104	RB5165	99	RB6154	95
RB41023	108	RB4826	108	RB5166	99	RB6155	95
RB41024	108	RB4826M	104	RB5172	107	RB6246	87
RB41025	108	RB4833	100	RB5173	107	RB6247	87
RB41026	108	RB4834	100	RB5174	107	RB6248	87
RB41051	100	RB4835	100	RB5175	107	RB6249	88
RB41052	100	RB4836	100	RB5176	107	RB6250	88
RB41053	100	RB4843	100	RB5562	103	RB6251	88
RB41054	100	RB4844	100	RB5563	103	RB6252	90
RB41055	100	RB4845	100	RB5564	103	RB6253	90
RB41056	100	RB4846	100	RB5565	103	RB6254	90
RB41091	100	RB4851	100	RB5566	103	RB6307	90
RB41122	108	RB4851M	104	RB5582	103	RB6308	90
RB41123	108	RB4853	100	RB5583	103	RB6309	90
RB41124	108	RB4854	100	RB5584	103	RB6401	94
RB41125	108	RB4855	100	RB5585	103	RB6402	94
RB41126	108	RB4856	100	RB5586	103	RB6403	94
RB41151	100	RB4860	100	RB5760	99	RB6404	94

RB6405	94	RB7730	120	RB7816	120	RB7969	125
RB6406	94	RB7731	120	RB7817	120	RB7970	125
RB6407	94	RB7732	120	RB7818	120	RB7971	125
RB6408	94	RB7733	120	RB7819	120	RB8631	147
RB6409	94	RB7734	120	RB7820	120	RB8731	147
RB6410	94	RB7735	120	RB7821	120	RB8800737	214
RB6415	94	RB7736	120	RB7822	120	RB8800738	214
RB6601	98	RB7737	120	RB7823	120	RB8800739	214
RB6602	98	RB7738	120	RB7824	120	RB8831	147
RB6603	98	RB7739	120	RB7825	120	RB8951	194
RB6604	98	RB7740	120	RB7826	120	RB8952	194
RB6605	98	RB7741	120	RB7827	120	RB9006	194
RB6606	98	RB7742	120	RB7828	120	RB9008	194
RB6621	98	RB7743	120	RB7829	120	RB9010	194
RB6622	98	RB7744	120	RB7830	120	RB9011	194
RB6623	98	RB7745	121	RB7831	120	RB9022	194
RB6641	98	RB7746	121	RB7832	120	RB9023	194
RB6642	98	RB7747	121	RB7833	120	RB9110	196
RB6643	98	RB7748	121	RB7900	125	RB9111	196
RB6801	97	RB7749	121	RB7901	125	RB9112	196
RB6802	97	RB7750	121	RB7902	125	RB9113	196
RB6803	97	RB7751	121	RB7903	125	RB9114	196
RB6804	97	RB7752	121	RB7904	125	RB9115	196
RB6805	97	RB7753	121	RB7905	125	RB9116	196
RB6806	97	RB7754	121	RB7906	125	RB9120	196
RB6821	97	RB7755	121	RB7907	125	RB9121	196
RB6822	97	RB7756	121	RB7908	125	RB9122	196
RB6823	97	RB7757	121	RB7909	125	RB9123	196
RB6841	97	RB7758	121	RB7910	125	RB9124	196
RB6842	97	RB7759	121	RB7911	125	RB9125	196
RB6843	97	RB7760	121	RB7920	125	RB9126	196
RB7170	124	RB7761	121	RB7921	125	RB9127	196
RB7181	124	RB7762	121	RB7922	125	RB9128	196
RB7281	124	RB7763	121	RB7923	125	RB9129	194
RB7701	120	RB7764	121	RB7924	125	RB9137	178
RB7702	120	RB7765	121	RB7925	125	RB9138	178
RB7703	120	RB7766	121	RB7926	125	RB9139	178
RB7704	120	RB7767	121	RB7927	125	RB9140	178
RB7705	120	RB7768	121	RB7928	125	RB9141	178
RB7706	120	RB7769	121	RB7929	125	RB9142	178
RB7707	120	RB7770	121	RB7930	125	RB9143	178
RB7708	120	RB7771	121	RB7931	125	RB9144	178
RB7709	120	RB7772	121	RB7940	125	RB9145	178
RB7710	120	RB7773	121	RB7941	125	RB9187	177
RB7711	120	RB7774	121	RB7942	125	RB9188	177
RB7712	120	RB7775	121	RB7943	125	RB9221	180
RB7713	120	RB7776	121	RB7944	125	RB9222	180
RB7714	120	RB7777	121	RB7945	125	RB9224	180
RB7715	120	RB7801	120	RB7946	125	RB9227	181
RB7716	120	RB7802	120	RB7947	125	RB9228	186
RB7717	120	RB7803	120	RB7948	125	RB9229	186
RB7718	120	RB7804	120	RB7949	125	RB9230	186
RB7719	120	RB7805	120	RB7950	125	RB9231	186
RB7720	120	RB7806	120	RB7951	125	RB9232	186
RB7721	120	RB7807	120	RB7960	125	RB9233	182
RB7722	120	RB7808	120	RB7961	125	RB9235	183
RB7723	120	RB7809	120	RB7962	125	RB9236	183
RB7724	120	RB7810	120	RB7963	125	RB9241	183
RB7725	120	RB7811	120	RB7964	125	RB9242	183
RB7726	120	RB7812	120	RB7965	125	RB9243	181
RB7727	120	RB7813	120	RB7966	125	RB9250	202
RB7728	120	RB7814	120	RB7967	125	RB9251	202
RB7729	120	RB7815	120	RB7968	125	RB9252	202

RB9253	202	RE0810	122	RN01252	123	RN0899	130
RB9339	168	RE0820	122	RN01253	123	RN0900	122
RB9340	168	RE0821	122	RN01254	123	RN0901	122
RB9341	168	RE0822	122	RN01255	123	RN0902	122
RB9342	168	RE0823	122	RN01256	123	RN0903	122
RB9343	168	RE0824	122	RN01257	123	RN0904	122
RB9344	167	RE0825	122	RN01258	123	RN0905	122
RB9345	167	RE0826	122	RN0127	173	RN0906	122
RB9346	167	RE0827	122	RN0128	10	RN0907	122
RB9347	167	RE0828	122	RN0140	207	RN0908	122
RB9348	167	RE0829	122	RN0188	176	RN0909	122
RB9477	209	RE0830	122	RN0189	176	RN0910	122
RB9617	206	RE0848	123	RN0210	12	RN0920	122
RB9618	206	RE0849	123	RN0211	12	RN0921	122
RB9619	206	RE0850	123	RN0222	16	RN0922	122
RBG4027	48	RE0851	123	RN0326	21, 213	RN0923	122
RBT1001	117	RE0852	123	RN0330	207	RN0924	122
RBT1002	123	RE0853	123	RN0331	207, 213	RN0925	122
RBT2120	49	RE0854	123	RN0332	207	RN0926	122
RBT2600	43	RE0855	123	RN0335	21	RN0927	122
RBT2660	47	RE0856	123	RN0401	15	RN0928	122
RBT2690	48	RE0857	123	RN0402	15	RN0929	122
RD4722	109	RE0858	123	RN0403	15	RN0930	122
RD4723	109	RN0061	6	RN0404	15	RN0945	132
RD4724	109	RN0062	6	RN0405	15	RN0946	132
RD4725	109	RN0070	6	RN0410	14	RN0947	132
RD4726	109	RN0071	6	RN0413	16	RN0948	123
RD4751	101	RN0072	6	RN0506	18	RN0949	123
RD4752	101	RN0073	6	RN0600	122	RN0950	123
RD4753	101	RN0074	5	RN06001	122	RN0951	123
RD4754	101	RN0075	5	RN0601	122	RN0952	123
RD4755	101	RN0076	5	RN0602	122	RN0953	123
RD4756	101	RN0077	5	RN0603	122	RN0954	123
RD4771	101	RN0120	8	RN0604	122	RN0955	123
RD4821M	105	RN01200	122	RN0605	122	RN0956	123
RD4822	109	RN01201	122	RN0606	122	RN0957	123
RD4822M	105	RN01202	122	RN0607	122	RN0958	123
RD4823	109	RN01203	122	RN0608	122	RN0960	127
RD4823M	105	RN01204	122	RN0609	122	RN0961	127
RD4824	109	RN01205	122	RN0710	52	RN0962	127
RD4824M	105	RN01206	122	RN0711	52	RN0981	130
RD4825	109	RN01207	122	RN0711N	52	RN0982	130
RD4825M	105	RN01208	122	RN0711W	52	RN0983	130
RD4826	109	RN01209	122	RN0712	52	RN0986	130
RD4826M	105	RN0121	8	RN0712N	52	RN0987	130
RD4851	101	RN01210	122	RN0712W	52	RN0988	130
RD4851M	105	RN01220	122	RN0713	52	RN0991	132
RD4853	101	RN01221	122	RN0713N	52	RN0992	132
RD4854	101	RN01222	122	RN0713W	52	RN0993	132
RD4855	101	RN01223	122	RN0714	52	RN0994	132
RD4856	101	RN01224	122	RN0714N	52	RN0995	132
RD4882	101	RN01225	122	RN0714W	52	RN0996	132
RD4891	101	RN01226	122	RN0820	129	RN1121	185
RE0800	122	RN01227	122	RN0821	129	RN1122	185
RE0801	122	RN01228	122	RN0822	129	RN1123	185
RE0802	122	RN01229	122	RN0881	130	RN1124	185
RE0803	122	RN0123	10	RN0882	130	RN1125	185
RE0804	122	RN01230	122	RN0883	130, 213	RN1126	185
RE0805	122	RN0124	10	RN0886	130	RN1127	185
RE0806	122	RN01248	123	RN0887	130	RN1127N	185
RE0807	122	RN01249	123	RN0888	130	RN1128	185
RE0808	122	RN01250	123	RN0897	130	RN1128N	185
RE0809	122	RN01251	123	RN0898	130	RN1129	185

RNI129N	185	RN2800	38	RN28415	39	RN4754	102
RNI170	128	RN2801	38	RN2877	28	RN4755	102
RNI171	128	RN2802	38	RN2878	28	RN4756	102
RNI172	128	RN2803	38	RN2879	28	RN4771	102
RNI173	128	RN28110	39	RN3022	82	RN4802	110
RNI180	128	RN28111	39	RN3023	82	RN4803	110
RNI181	128	RN28112	39	RN3024	82	RN4804	110
RNI182	128	RN28113	39	RN3025	82	RN4805	110
RNI183	128	RN28114	39	RN3026	82	RN4806	110
RN2015	64	RN28115	39	RN3030	85	RN4812	110
RN2102	55	RN28116	39	RN3031	85	RN4813	110
RN2104	56	RN28117	39	RN3032	85	RN4814	110
RN2105	56	RN28118	39	RN3033	85	RN4815	110
RN2210	57	RN28119	39	RN3034	85	RN4816	110
RN2211	57	RN28120	39	RN3035	85	RN4819	112
RN2212	57	RN28121	39	RN41022	110	RN4821M	106
RN2213	57	RN28122	39	RN41023	110	RN4822	110
RN2300	59	RN28123	39	RN41024	110	RN4822M	106
RN2301	59	RN28124	39	RN41025	110	RN4822X	111
RN2302	59	RN28125	39	RN41026	110	RN4823	110
RN2320	61	RN28126	39	RN41051	102	RN4823M	106
RN2321	61	RN28127	39	RN41052	102	RN4823X	111
RN2322	61	RN28210	39	RN41053	102	RN4824	110
RN2323	61	RN28211	39	RN41054	102	RN4824M	106
RN2400	65	RN28212	39	RN41055	102	RN4824X	111
RN2401	65	RN28213	39	RN41056	102	RN4825	110
RN2402	65	RN28214	39	RN41091	102	RN4825M	106
RN2403	65	RN28215	39	RN41122	110	RN4825X	111
RN2404	65	RN28216	39	RN41123	110	RN4826	110
RN2405	65	RN28217	39	RN41124	110	RN4826M	106
RN2406	65	RN28218	39	RN41125	110	RN4826X	111
RN2407	65	RN28219	39	RN41126	110	RN4833	102
RN2408	65	RN28220	39	RN41151	102	RN4834	102
RN2409	65	RN28221	39	RN41152	102	RN4835	102
RN2501	66	RN28222	39	RN41153	102	RN4836	102
RN2502	66	RN28223	39	RN41154	102	RN4843	102
RN2503	66	RN28224	39	RN41155	102	RN4844	102
RN2504	66	RN28225	39	RN41156	102	RN4845	102
RN2506	66	RN28226	39	RN41191	102	RN4846	102
RN2528	72	RN28227	39	RN4719	112	RN4851	102
RN2536	69	RN28310	39	RN4720	112	RN4851M	106
RN2540	70	RN28311	39	RN4721M	106	RN4853	102
RN2575	208	RN28312	39	RN4722	110	RN4854	102
RN2576	208	RN28313	39	RN4722M	106	RN4855	102
RN2577	208	RN28314	39	RN4722X	111	RN4856	102
RN2578	208	RN28315	39	RN4723	110	RN4860	102
RN2614	70	RN28316	39	RN4723M	106	RN4861	102
RN2673	62	RN28317	39	RN4723X	111	RN4862	102
RN2688	63	RN28318	39	RN4724	110	RN4863	102
RN2689	63	RN28319	39	RN4724M	106	RN4864	102
RN2720	67	RN28320	39	RN4724X	111	RN4865	102
RN2721	67	RN28321	39	RN4725	110	RN4866	102
RN2722	67	RN28322	39	RN4725M	106	RN4872	102, 213
RN27225	67	RN28323	39	RN4725X	111	RN4872D	116
RN2723	67	RN28324	39	RN4726	110	RN4873D	116
RN27235	67	RN28325	39	RN4726M	106	RN4874D	116
RN2724	67	RN28326	39	RN4726X	111	RN4875D	116
RN27245	67	RN28327	39	RN4737	112	RN4882	102, 213
RN2725	68	RN28410	39	RN4739	112	RN4890	102
RN2726	68	RN28411	39	RN4751	102	RN4891	102, 213
RN2727	68	RN28412	39	RN4751M	106	RN4892	102
RN2728	68	RN28413	39	RN4752	102	RN4892E	113
RN2729	68	RN28414	39	RN4753	102	RN4893	113

RN4894	113	RN5682	87	RN5980	87	RN6605	155
RN4895	113	RN5703	92	RN5981	87	RN6606	155
RN4896	113	RN5704	92	RN5982	87	RN6607	155
RN4922	110	RN5705	92	RN6021	9, 213	RN6608	155
RN4923	110	RN5712	87	RN6200	150	RN6609	156
RN4924	110	RN5712H	87, 213	RN6201	151	RN6610	156
RN4925	110	RN5712X	87	RN6202	151	RN6611	156
RN4926	110	RN5722	87	RN6203	151	RN6612	156
RN4951	102	RN5722H	87, 213	RN6204	151	RN6613	156
RN4952	102	RN5722X	87	RN6205	151	RN6614	156
RN4953	102	RN5732	87	RN6206	151	RN6615	156
RN4954	102	RN5732H	87	RN6207	151	RN6616	156
RN4955	102	RN5732X	87	RN6208	151	RN6617	156
RN4956	102	RN5743	88	RN6209	151	RN6626	157
RN4991	102	RN5743H	48, 88	RN6210	151	RN6700	153
RN5000	213	RN5743HX	48, 88	RN6211	152	RN6701	153
RN51112H	87	RN5743X	88	RN6212	152	RN6702	153
RN51122H	87	RN5744	90	RN6213	152	RN6703	153
RN51132H	87	RN5744H	90	RN6214	152	RN6704	153
RN51143H	88	RN5744X	90	RN6215	152	RN6705	153
RN51144H	90	RN5753	88	RN6216	152	RN6706	153
RN51153H	88	RN5753H	88	RN6217	152	RN6707	153
RN51154H	90	RN5753HX	88	RN6218	152	RN6708	153
RN51163H	88	RN5753X	88	RN6219	152	RN6709	154
RN51164H	90	RN5754	90	RN6220	152	RN6710	154
RN51212H	87	RN5754H	90	RN6230	150	RN6711	154
RN51222H	87	RN5754X	90	RN6240	193	RN6712	154
RN51232H	87	RN5763	88	RN6241	193	RN6713	154
RN51243H	88	RN5763H	88	RN6253	195	RN6714	154
RN51244H	90	RN5763HX	88	RN6254	195	RN6715	154
RN51253H	88	RN5763X	88	RN6255	195	RN6716	154
RN51254H	90	RN5764	90	RN6256	195	RN6717	154
RN51263H	88	RN5764H	90	RN6271	201	RN7021	204, 213
RN51264H	90	RN5764X	90	RN6272	201	RN7022	204, 213
RN5423	206, 213	RN5780	87, 213	RN6273	201	RN7023	204, 213
RN5424	206, 213	RN5781	87	RN6274	201	RN7061	204, 213
RN5512H	87	RN5782	87	RN6300	211	RN7127	96
RN5522H	87	RN5802	96	RN6301	211, 213	RN7128	96
RN5526	92	RN5803	96	RN6302	211, 213	RN7129	96
RN5527	92	RN5804	96	RN6303	211, 213	RN7130	96
RN5528	92	RN5805	96	RN6304	211, 213	RN7131	96, 213
RN5532H	87	RN5806	96	RN6305	211	RN7132	95
RN5543H	88	RN5808	96	RN6305L	211	RN8001	197
RN5544H	90	RN5812	96	RN6306	211	RN8001B	197
RN5553H	88	RN5813	96	RN6306L	211	RN8002	197
RN5554H	90	RN5814	96	RN6307	211, 213	RN8002B	197
RN5563H	88	RN5816	96	RN6308	211, 213	RN8003	197
RN5564H	90	RN5822	96	RN6309	212	RN8003B	197
RN5603	92	RN5823	96	RN6310	212	RN8004	197
RN5604	92	RN5824	96	RN6311	212	RN8004B	197
RN5605	92	RN5826	96	RN6312	212	RN8005	197
RN5612H	87	RN5903	92	RN6313	212	RN8005B	197
RN5622H	87	RN5904	92	RN6314	212	RN8006	197
RN5622X	87	RN5905	92	RN6315	212	RN8006B	197
RN5632H	87	RN5912H	87	RN6316	212	RN8007	197
RN5643H	88	RN5922H	87	RN6320	211	RN8007B	197
RN5644H	90	RN5932H	87	RN6323	211, 213	RN8008	197
RN5653H	88	RN5943H	88	RN6324	211, 213	RN8008B	197
RN5654H	90	RN5944H	90	RN6600	155	RN8009	197
RN5663H	88	RN5953H	88	RN6601	155	RN8009B	197
RN5664H	90	RN5954H	90	RN6602	155	RN8020	195
RN5680	87	RN5963H	88	RN6603	155	RN8021	195
RN5681	87	RN5964H	90	RN6604	155	RN8022	195

RN8023	195	RN8269	146	RN8705	139	RN9310	143
RN8025	202	RN82725	144, 213	RN8706	139	RN9312	143
RN8026	202	RN82727	144, 213	RN8707	139	RN9405	143
RN8028	179	RN82810	146	RN8708	139	RN9407	143
RN8029	179	RN82812	146	RN8709	139	RN9410	143
RN8030	179	RN8283	146	RN8710	139	RN9505	143
RN8031	179	RN8284	146	RN8711	139	RN9507	143
RN8032	179	RN8285	146	RN8712	139	RN9510	143
RN8033	179	RN8286	146	RN87210	139	RN9625	142
RN8034	179	RN8287	146	RN87211	139	RN9627	142
RN8036	179	RN8288	146	RN87212	139	RN9725	142
RN8060	193	RN8289	146	RN8723	139	RN9727	142
RN8061	193	RN8275	200	RN8724	139	RR2201	182
RN8065	195	RN8276	200	RN8725	139	RR2202	182
RN8066	195	RN8294	176	RN8726	139	RR2203	182
RN8111	175	RN8295	176	RN8727	139	RR2204	182
RN8112	175	RN8297	200	RN8728	139	RR2205	182
RN8113	175	RN8298	200	RN8729	139	RR2206	182
RN8114	175	RN8299	200	RN87610	138	RR2207	182
RN8121	172	RN8503	139	RN87611	138	RR2208	182
RN8122	172	RN8504	139	RN87612	138	RR2209	182
RN8123	172	RN8505	139	RN8763	138	RR2301	182
RN8124	172	RN8506	139	RN8764	138	RR2302	182
RN8125	172	RN8507	139	RN8765	138	RR2303	182
RN8126	172	RN8508	139	RN8766	138	RR2304	182
RN8127	172	RN8509	139	RN8767	138	RR2305	182
RN8128	172	RN8510	139	RN8768	138	RR2306	182
RN8136	200	RN8511	139	RN8769	138	RR2307	182
RN8137	200	RN8512	139	RN87810	138	RR2308	182
RN8142	193	RN85210	139	RN87811	138	RR2309	182
RN8143	193	RN85211	139	RN87812	138	RR2401	182
RN8144	193	RN85212	139	RN8783	138	RR2402	182
RN8145	195	RN8523	139	RN8784	138	RR2403	182
RN8146	195	RN8524	139	RN8785	138	RR2404	182
RN8147	195	RN8525	139	RN8786	138	RR2405	182
RN8148	195	RN8526	139	RN8787	138	RR2406	182
RN8149	195	RN8527	139	RN8788	138	RR2407	182
RN82325	144, 213	RN8528	139	RN8789	138	RR2408	182
RN82327	144, 213	RN8529	139	RN9000L	145	RR2409	182
RN82425	144, 213	RN85610	138	RN9000R	145	RR2501	182
RN82427	144, 213	RN85611	138	RN9000T	145	RR2502	182
RN82510	146	RN85612	138	RN9001L	145	RR2503	182
RN82512	146	RN8563	138	RN9001R	145	RR2504	182
RN825211	144, 213	RN8564	138	RN9001T	145	RR2505	182
RN82525	144, 213	RN8565	138	RN9002L	145	RR2506	182
RN82527	144, 213	RN8566	138	RN9002R	145	RR2507	182
RN8253	146	RN8567	138	RN9002T	145	RR2508	182
RN8254	146	RN8568	138	RN9003L	145	RR2509	182
RN8255	146	RN8569	138	RN9003R	145	RR2601	183
RN8256	146	RN85810	138	RN9003T	145	RR2602	183
RN8257	146	RN85811	138	RN9103	143	RR2603	183
RN8258	146	RN85812	138	RN9105	143	RR2604	183
RN8259	146	RN8583	138	RN9107	143	RR2605	183
RN82610	146	RN8584	138	RN9110	143	RR2606	183
RN82612	146	RN8585	138	RN9112	143	RR2607	183
RN82625	144, 213	RN8586	138	RN9203	143	RR2608	183
RN82627	144, 213	RN8587	138	RN9205	143	RR2609	183
RN8263	146	RN8588	138	RN9207	143	RR2701	183
RN8264	146	RN8589	138	RN9210	143	RR2702	183
RN8265	146	RN8612	141	RN9212	143	RR2703	183
RN8266	146	RN8615	141	RN9303	143	RR2704	183
RN8267	146	RN8703	139	RN9305	143	RR2705	183
RN8268	146	RN8704	139	RN9307	143	RR2706	183

RR2707	183	RR8130	134	RU2431	37
RR2708	183	RR8131	134	RU2432	37
RR2709	183	RR8132	134	RU2433	37
RR2710	183	RR8133	134, 135	RU2434	37
RR2711	183	RR8200	135	RU2435	37
RR2712	183	RR8210	135	RU2436	37
RR2804	184	RR8211	135	RU2437	37
RR2805	184	RR8212	135	RU2438	37
RR2806	184	RR8213	135	RU2439	37
RR2807	184	RR8214	135	RU2446	37
RR2808	184	RR8215	135	RU2447	37
RR2809	184	RR8216	135	RU2448	37
RR2810	184	RR8217	135	RU2449	37
RR2811	184	RR8218	135	RU2450	37
RR2812	184	RR8219	135	RU2451	37
RR5712X	87	RR8220	135	RU2452	37
RR5722X	87	RR8221	135	RU2453	37
RR8000	136	RR8222	135	RU2454	37
RR8010	136	RR8223	135	RU2455	37
RR8011	136	RR8224	135	RU2456	37
RR8012	136	RR8225	135	RU2457	37
RR8013	136	RR8226	135	RU2464	37
RR8014	136	RR8227	135	RU2465	37
RR8015	136	RR8228	135	RU2466	37
RR8016	136	RR8229	135	RU2467	37
RR8017	136	RR8230	135	RU2468	37
RR8018	136	RR8231	135	RU2469	37
RR8019	136	RR8232	135		
RR8020	136	RS0900	123		
RR8021	136	RS1120	185		
RR8022	136	RS5000	213		
RR8023	136	RS2400	36		
RR8024	136	RS2800	38		
RR8025	136	RS6219	152		
RR8026	136	RS6600	156		
RR8027	136	RS6700	154		
RR8028	136	RS8000	197		
RR8029	136	RT0145	179		
RR8030	136	RT0146	179		
RR8031	136	RU2400	36		
RR8032	136	RU2403	37		
RR8033	136	RU2404	37		
RR8100	134	RU2405	37		
RR8110	134	RU2406	37		
RR8111	134	RU2407	37		
RR8112	134	RU2408	36		
RR8113	134	RU2409	36		
RR8114	134	RU2410	37		
RR8115	134	RU2411	37		
RR8116	134	RU2412	37		
RR8117	134	RU2413	37		
RR8118	134	RU2414	37		
RR8119	134	RU2415	37		
RR8120	134	RU2416	37		
RR8121	134	RU2417	37		
RR8122	134	RU2418	37		
RR8123	134	RU2419	37		
RR8124	134	RU2420	37		
RR8125	134	RU2421	37		
RR8126	134	RU2422	36		
RR8127	134	RU2428	37		
RR8128	134	RU2429	37		
RR8129	134	RU2430	37		

Integra™ Ruggles™-Redmond™

Neuro/Spine Surgical Instruments

For more information or to place an order, please contact:
Integra ■ 589 Davies Drive, York, PA 17402
877-468-5572 USA ■ 800-275-7192 fax
914-789-7094 outside USA ■ 609-750-4218 outside USA fax
integralife.com

